



Endorsed By



---

RUGBY

---

LEAGUE

---

COACHING

---

MANUALS

---

Since 1993

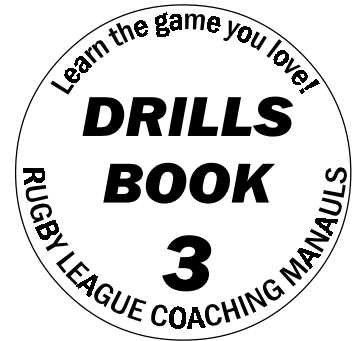

# DRILLS BOOK (3)

## CONTENTS

**74**  
*Drills*

- 2 Evasion Drills
- 21 Catch & Pass Drills
- 36 Basic Training Drills
- 52 Training Drills
- 62 Off-Load Drills
- 70 Kicking Drills

[www.rlcm.com.au](http://www.rlcm.com.au)



VISIT THE WEBSITE TODAY!!

# DRILLS BOOK..( 3 )

## *Evasion* DRILLS

RLCM would like to thank Dave Ellis, Digi League and John Dixon, Brisbane Broncos for their assistance in compiling these drills.

**Visit the RLCM website to order Drills Books [www.rlcm.com.au](http://www.rlcm.com.au)**

- 1. Side Step 1
- 2. Side Step 2
- 3. Side Step 3
- 4. Side Step 4
- 5. Side Step 5
- 6. Swerve
- 7. Fend
- 8. Change of Pace
- 9. Side On Evasion
- 10. Evasion Grid 1
- 11. Evasion Grid 2
- 12. Evasion Grid 3
- 13. 1-on-1 Offensive/Defensive
- 14. Pick The Gap
- 15. Evasion Channel 2
- 16. Evasion Channel 3
- 17. Run The Gauntlet



<input type="radio"/>	<b>RLCM</b>	1- 29
<input type="radio"/>	<b>Drills Books</b>	1 & 2
<input type="radio"/>	<b>Coach Talk</b>	1 & 2
<input type="radio"/>	<b>Junior Coaching</b>	1

Order your CD Now Freecall 1800 18 14 14



VISIT THE WEBSITE TODAY!!

# DRILLS BOOK..( 3)

## Side Step 1

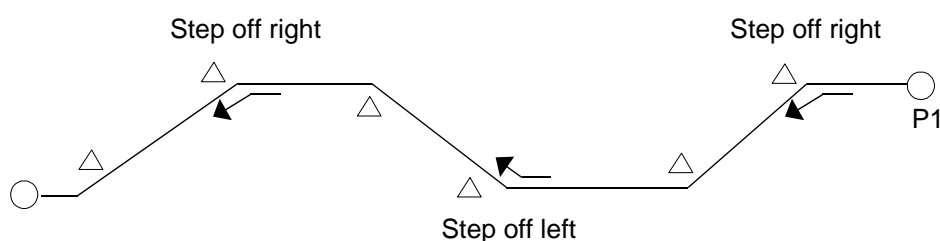

### Setting

Any number of players, area 20m X 8m

- P1 carrying football in two hands moves down the grid
- At first set of markers player steps off the right foot
- At the next set the player steps off the left

### Progression

- Add static and then active defenders positioned at the markers
- Player transfers the ball to outside arm, allowing the inside arm the fend if required

RUGBY	<b>SUBSCRIBE NOW</b> <b>BI-MONTHLY</b> <b>www.rlcm.com.au</b>
LEAGUE	
COACHING	
MANUALS	
Since 1993	



VISIT THE WEBSITE TODAY!!

# DRILLS BOOK..( 3 )

## Side Step 2

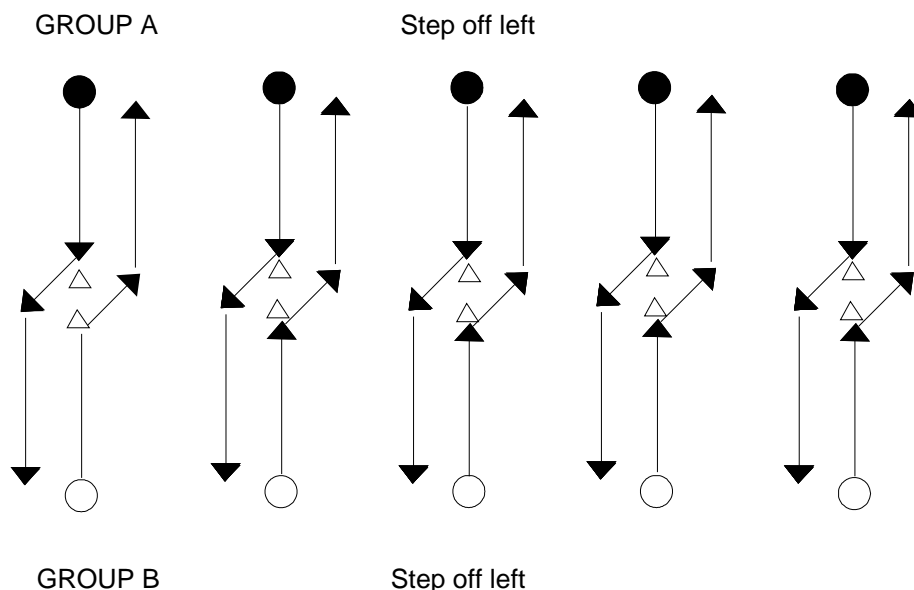

### Setting

Any number of players, area 20m X 10m

- Players divide into two even groups facing each other across the grid
- Players run toward each other and as they approach step and then accelerate past their opposite
- All players need to step off the same foot to avoid collisions, start with left and the right
- Once all players are using correct technique, coach should start to call left or right as players approach each other

### Progression

- Add football with one team being the attackers who should attempt to evade the oncoming defender



VISIT THE WEBSITE TODAY!!

# DRILLS BOOK..( 3 )

## Side Step 3

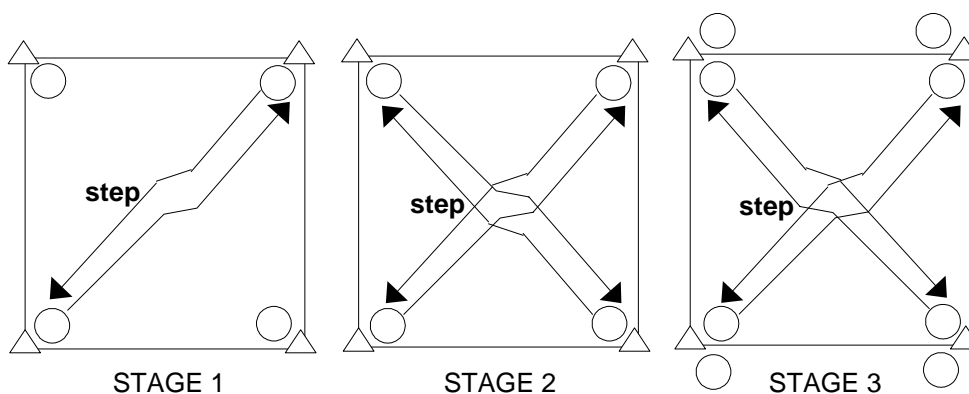

### Setting

Minimum of 4 players, area 10m X 10m

- This drill has three stages
- Players start from each corner of the grid

### Stage 1

- 2 Players on opposite corners simultaneously run towards each other, stepping to avoid each other and then proceeding to the opposite corner

### Stage 2

- Players from all four corners start at the same time, stepping as they approach each other

### Stage 3

- As in stage two, however 2 players should carry ball in hand, progressing from a two handed carry, to a one handed carry to a one handed carry with fend if required



VISIT THE WEBSITE TODAY!!

# DRILLS BOOK..( 3 )

## Side Step 4

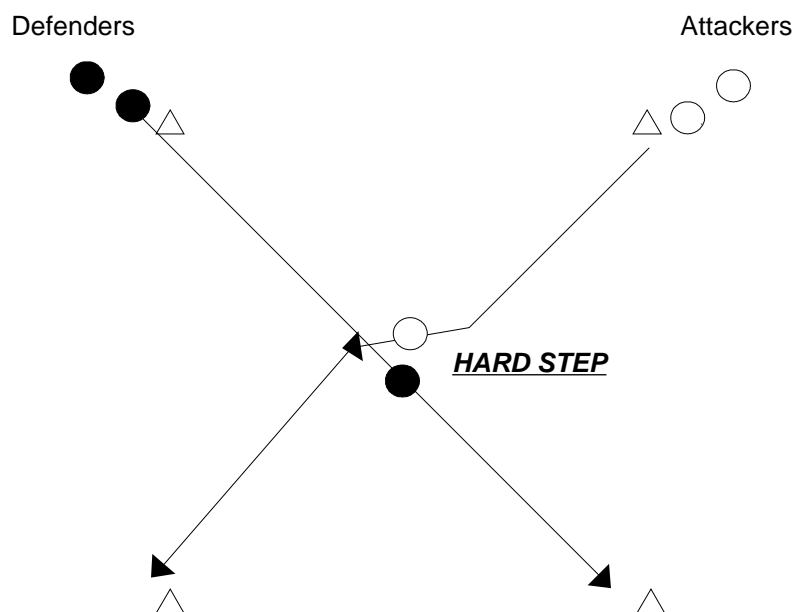

### Setting

Minimum of 4 players, area 15m X 15m

- Players divide into two equal groups at adjacent corners of the grid
- Each player in one group has a football they are the attackers the other group is the defenders
- When the attacking player begins his diagonal run, the opposite defender reacts by running his diagonal line
- The defenders job is to act as a moving target for the attacker. He should not attempt to grab or slow down the run of the attacker
- The attacker steps the defender with an explosive step and then accelerates to the opposite end of the grid.
- Once all players have run through they should return running the same lines, after at least 4 run throughs the groups should change roles



VISIT THE  
WEBSITE TODAY!!

## DRILLS BOOK..( 3 )

### Side Step 5

---

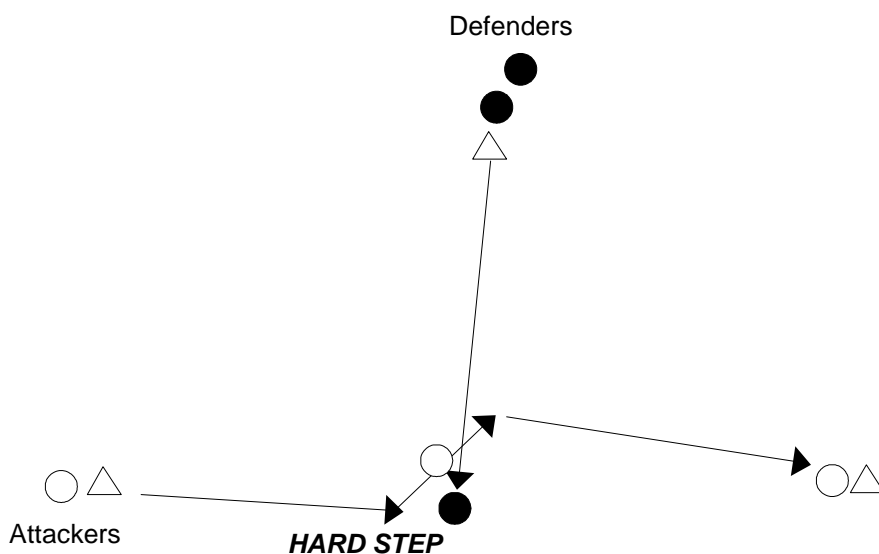

#### Setting

Minimum of 4 players, area 20m X 15m

- Players divide into two equal groups
- One attacker and one defender move out from the starting marker
- The attacker drifts his run a little to the right before stepping back on the inside of the defender
- He then accelerates to the marker at the opposite end of grid where he hands the ball over to the next attacker who moves in from the opposite direction perform a 'left to right' step
- Defenders should attempt a two handed grab on the attacking player and then returning to the starting position by going around the outside of the grid



VISIT THE  
WEBSITE TODAY!!

## DRILLS BOOK..( 3 )

### Swerve

---

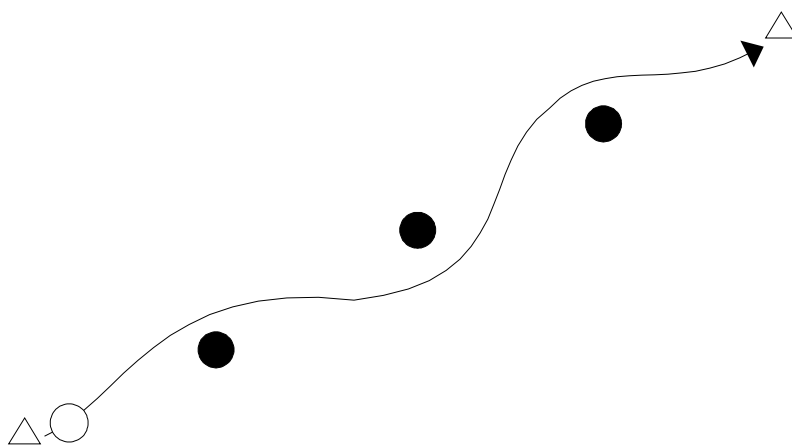

#### Setting

Minimum of 4 players, area 5m X 20m

- Drill begins with players swerving around markers that are placed approx. 5 metres apart
- Defenders are positioned on the markers, they can not use their arms and are allowed to take only one step sideways, forcing the runners to widen their swerving run
- Progress by widening the distance to approx 8 metres between defenders. Defenders are allowed to use their arms now as well as the step and attempt to tag the runners
- Next progression is defenders can take one step to the front, back or side and can use their arms to make it more difficult for the runners





VISIT THE WEBSITE TODAY!!

# DRILLS BOOK..( 3 )

## Fend 1

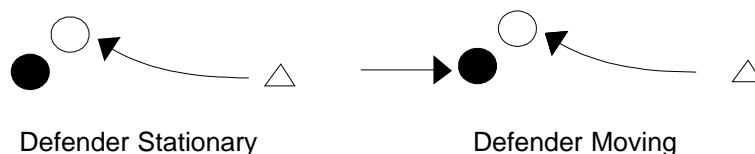

### Setting

Minimum of 2 players, area 5m X 20m

- Attackers are split into 2 groups with a defenders between them
- An attacking player with ball in hand moves down the grid and fends the defender away before offloading to the next attacker
- Initially the defender should remain stationary, and then progressing so the defender is allowed to move in on the attacker

## Fend 2

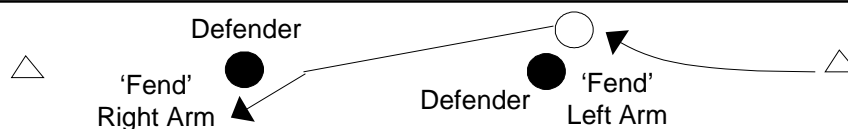

### Setting

Groups of 6 to 8 players, area 40m X 10m

- All attackers start at one end of the grid
- 2 defenders are placed 10 metres in the grid
- Each attacker runs with the football and performs a left handed fend on the first defender and then a right handed fend on the second defender
- Attackers then return repeating the exercise in the opposite direction



VISIT THE WEBSITE TODAY!!

# DRILLS BOOK..( 3 )

## Change of Pace

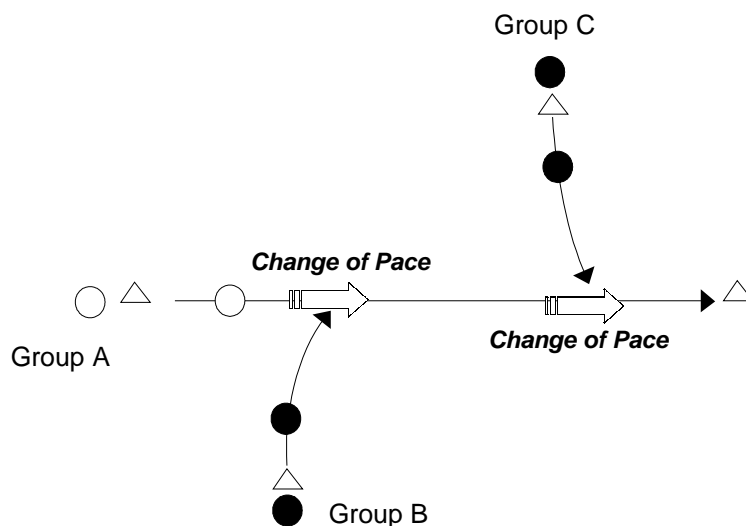

### Setting

Minimum of 3 players, area 40m X 40m

- Players are divide into 3 groups A, B, C
- Group A runs the change of pace and groups B and C act as defenders positioned on opposite sides of the channel
- The attacking player should carry a football, or, if balls are not available a marker or shoe will suffice
- Attacker runs down the grid, if the defender gets too close the ball should be transferred to the outside arm and the inside arm should be used to fend
- There should be at least 20 metres distance between the defending groups, allowing the attacker to accelerate away from the first defender and then readjusting to take on the next defender
- The drill can be made continuous by rotating the players after each involvement. Players from A joins C, C joins Band B joins A
- If the defender has mis-timed his run and come to far across the attacking player can step to the inside or position his body for an imaginary bump off



VISIT THE WEBSITE TODAY!!

# DRILLS BOOK..( 3 )

## Side on Evasion

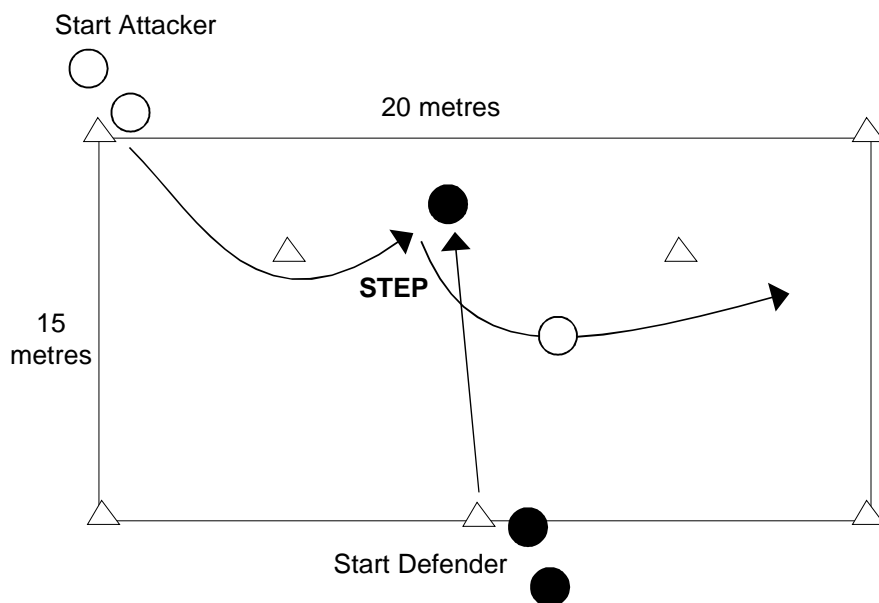

### Setting

Area 15m X 20m

- Grid should be set up wide enough to give attacking player a fair chance of succesful evasion
- Attacking player moves from start position holding ball in either two hands or the arm furthest from defender
- After rounding first marker the defender must react to the movements of the defender
- If the defender has come across to far the attacking option may be to step him on the inside, if the defender has not come up far enough the option may be to accelerate away from him using the sideline
- This drill is both evasive and tackling, if the attacking player is tackled he should get to his feet quickly and play the ball



VISIT THE WEBSITE TODAY!!

# DRILLS BOOK..( 3 )

## Evasion Grid 1

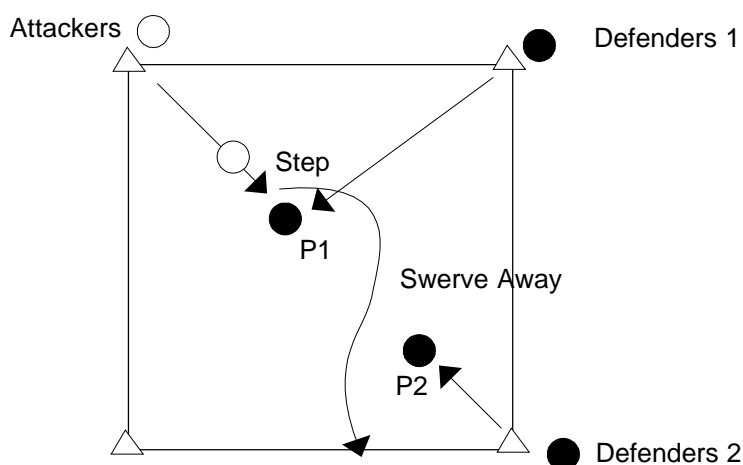

### Setting

Minimum of 3 players, Area 15m X 20m

- The aim of this drill is to develop swerve and side step skills
- Equal numbers of players are positioned on three corners of the grid
- The first attacker runs out on a diagonal line across the grid
- The first defender (P1) runs out at the same time from the other diagonal and acts as a moving target for the attacker to practice his side step
- The attacking player should step the defender on the inside and then quickly adopt a line that gives him the best chance of beating the second defender (P2)
- The attacker should be encouraged to beat the second defender on the outside
- There is no try line in this drill, the attacker should simply attempt to evade the two defenders and develop good footwork



VISIT THE WEBSITE TODAY!!

# DRILLS BOOK..( 3 )

## Evasion Grid 2

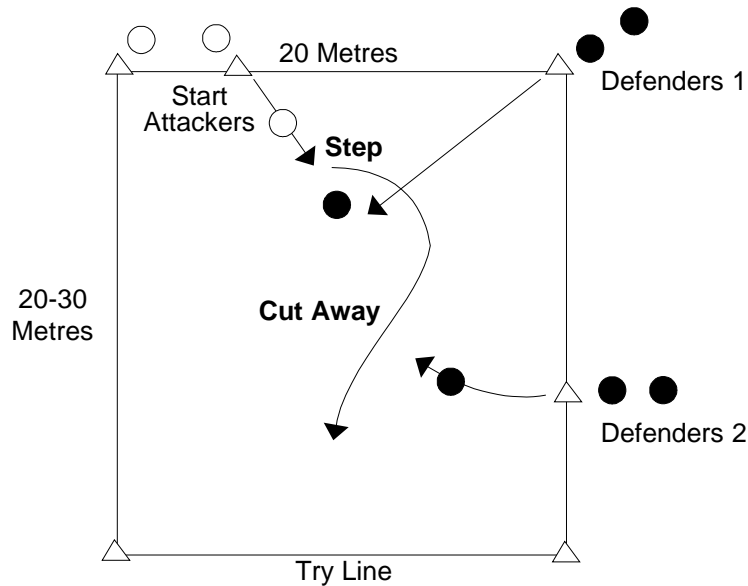

### Setting

Minimum of 3 players, Area 20m X 20m

- Continuation of 'Evasion Grid 1'
- Players are divided into 3 groups and positioned on markers as shown in the diagram
- The aim of the attacker is to score a try at the opposite end of the grid (try line)
- Attacker runs from start line and must evade first defender coming in from the side and then second defender from a more front on position
- Attacker must use either acceleration, swerve or inside step if the defender as come across to far
- Second defender can only move once attacker has begun evasive action on first defender, or, on the coaches signal
- Players should rotate after each involvement, attacker joins defender 1, defender 1 joins defender 2, defender 2 joins attackers



VISIT THE WEBSITE TODAY!!

# DRILLS BOOK..( 3 )

## Evasion Grid 3

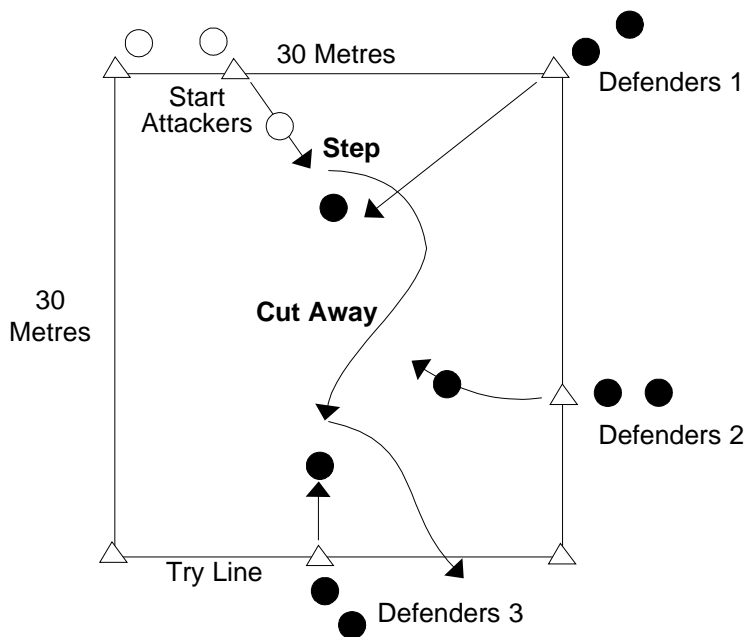

### Setting

Minimum of 4 players, Area 30m X 30m

- Drill is continuation of 'Evasion Grid 2'
- Players are divided into 4 groups and positioned on markers as shown in the diagram
- This drill is the same as 'Evasion Grid 2' however there is another group of defenders added at the end of the grid who advance towards the attacker from a front on position
- The attacker must use acceleration, swerve or step and defenders can only move when the evasive action has begun on the defender before them
- Attacker must attempt to score a try
- Players rotate as previous



VISIT THE WEBSITE TODAY!!

# DRILLS BOOK..( 3 )

## Evasion Channel 1

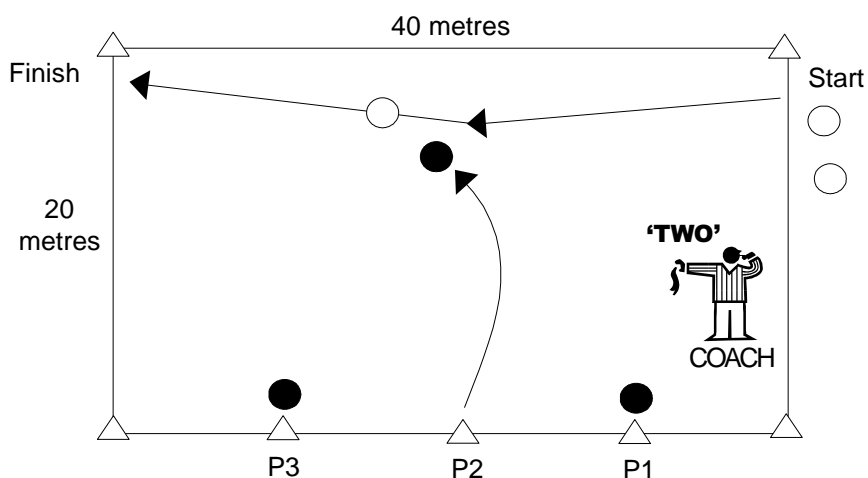

### Setting

Minimum of 6 players, Area 40m X 20m

- Players are divided into 2 groups with defenders positioned on markers and number P1, P2 and P3
- Coach begins the drill by calling either One, Two or Three
- On a call of Two, the first attacker would accelerate down the channel and the defender who's number was called would move across and attempt to perform a two handed grab on the attacker
- As the defenders are positioned differently the attacker is confronted with a single defender coming from different positions and angles
- The aim of the drill is to develop evasive skills and decision making on what evasive action to take
- Coach can experiment with position of defenders for variation



VISIT THE WEBSITE TODAY!!

# DRILLS BOOK..( 3)

## Evasion Channel 2

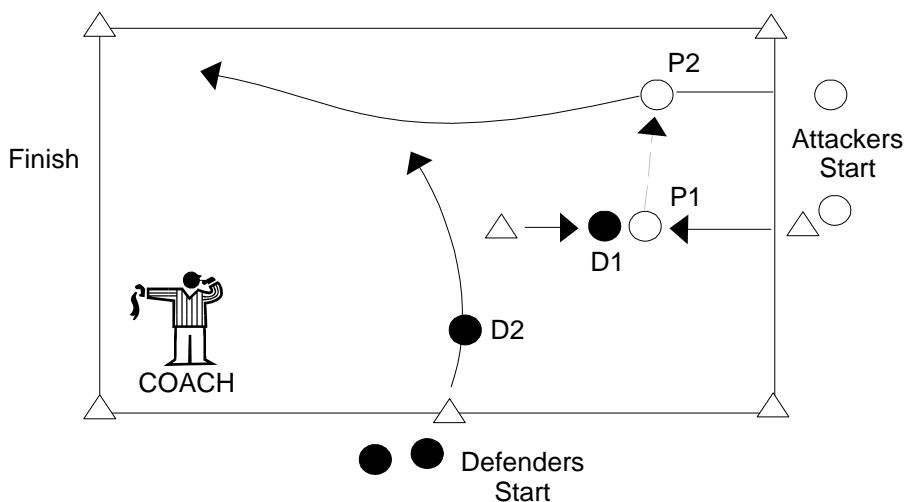

### Setting

Minimum of 8 players, Area 40m X 20m

- Drill is continuation from 'Evasion Channel 1'
- This drill can be performed with 4 players, however, it works better with a larger group or full team. We will assume we have 13 players
- One player is nominated as the Defender (D1) and is positioned near the middle of the channel
- The remaining players are divided into 6 groups of 2
- 4 of the groups are positioned at the attackers start line and the other 2 (4 players) are positioned at the defenders start
- On the coaches command the first pair of attackers (P1 and P2) move down the channel, P1 draws D1 before passing to P2
- At the instant P1 makes the pass, D2 moves across and attempts to tag P2 with two hands as he tries to score at the other end of the channel





VISIT THE  
WEBSITE TODAY!!

## DRILLS BOOK..( 3)

### Evasion Channel 3

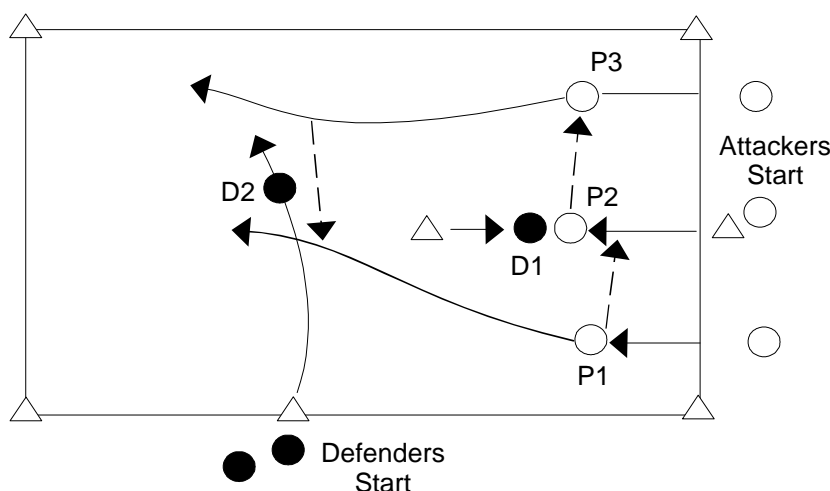

#### Setting

Team, Area 40m X 20m

- Drill is continuation from 'Evasion Channel 2'
- This drill works well with 5 players however it works better with a larger group or full team. We will assume we have 13 players
- One player is nominated as the Defender (D1) and is positioned near the middle of the channel
- The remaining players are divided into 4 groups of 3
- 3 of the groups are positioned at the attackers start line and the other group is at the defenders start
- On the coaches command the first trio of attackers (P1, P2, P3) advance on D1
- P1 passes a late pass to P2 who is now under pressure and must quickly move the ball on to P3
- At the instant P2 makes the pass, D2 moves across and attempts to tag P2 with two hands
- P1 moves into a support position and in most cases will receive an inside pass from P3



VISIT THE  
WEBSITE TODAY!!

## DRILLS BOOK..( 3 )

# 1-On-1 Offensive/Defensive

---

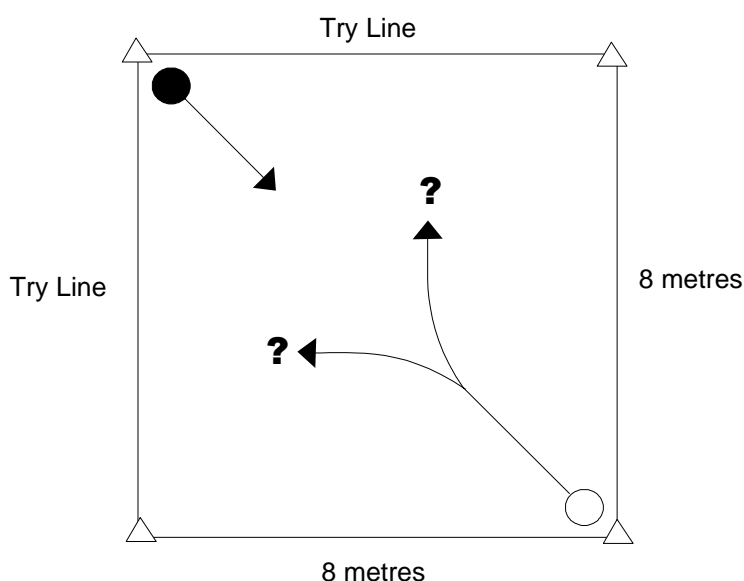

### Setting

2 players, Area 8m X 8m

- Players work in pairs alternating between defender and attacker
- Each player starts on a cone diagonally opposite each other
- On 'GO" players run out from their corner directly towards each other
- The attacking player runs straight for approx. 3 metres and then performs an evasive action
- The attacker has the option of attacking the left or right side of the grid diagonally opposite his starting corner and must attempt to score on the selected side
- The defender attempts a two handed grab on the attacker before he crosses his nominated try line
- Attacker should carry ball in two hands until making decision on whether to attack the left or right



VISIT THE WEBSITE TODAY!!

# DRILLS BOOK..( 3 )

## Pick The Gap

---

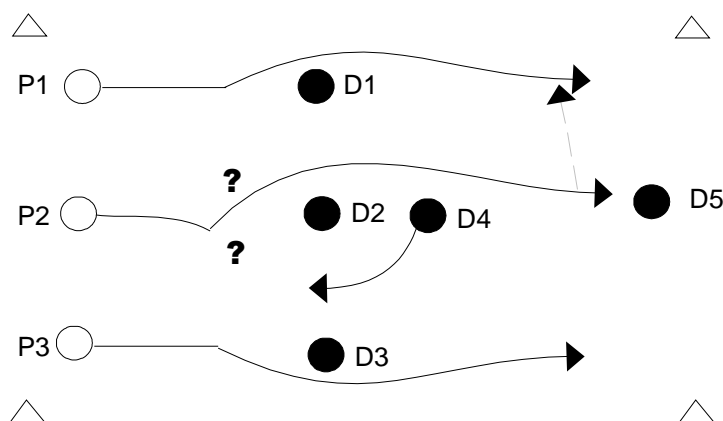

### Setting

8 players, Area 30m X 20m

- Players are divided into 2 groups (3 attackers and 5 defenders)
- Attacking group (A1, A2, A3) move down the channel attempting to score at the other end
- Three defenders (D1, D2, D3) line up across the channel with a fourth defender (D4) positioned just behind them. The fifth defender (D5) is at the far end of the channel
- As A2 approaches the defender in the middle of the defensive line, D4 moves into the gap Between D2 and D3 or D2 and D1
- P2 must react and step D2 moving into the gap that is available
- P2 then accelerates forward and draws D5 before passing to either A1 or A3 which are in support



VISIT THE WEBSITE TODAY!!

# DRILLS BOOK..( 3)

## Run The Gauntlet

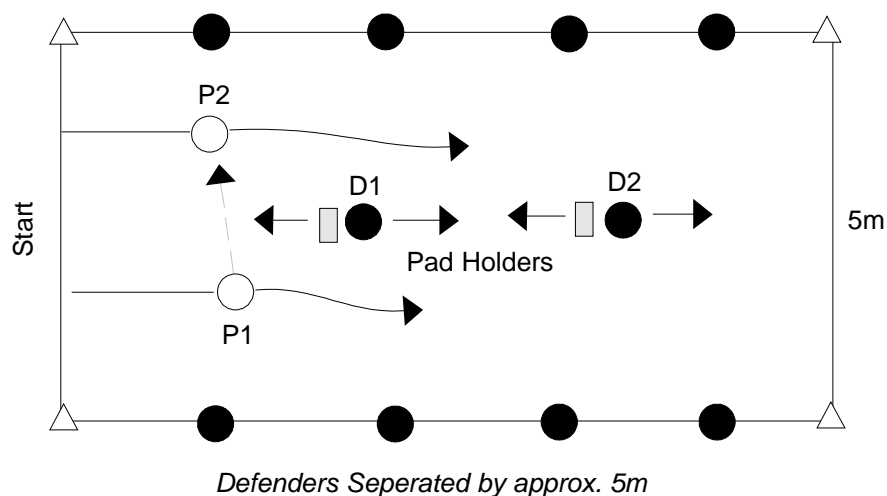

### Setting

Approx. 12 players, Area 20m X 5m channel

- Channel is set up with two attackers (P1 and P2), two pad holders (D1 and D2) and remaining players positioned equally along the side of the channel
- P1 and P2 work down the channel using evasive skills and must avoid being two hand tagged by the players on the side or being hit by D1 or D2
- The defenders along the side can only take one step into the channel and must keep the other foot planted firmly on thesideline
- D1 and D2 positioned in the middle of the channel can only move back or forward and NOT sideways
- After reaching the end of the channel the attackers turn and repeat the exercise in the opposite direction
- Add competition by giving a point each time the attackers are tagged or solidly hit by the pads, the team with the lowest points wins



VISIT THE  
WEBSITE TODAY!!

## DRILLS BOOK..( 3 )

# RLCM Drills

## *Catch & Pass*

RLCM would like to thank Dave Ellis, Digi League and John Dixon, Brisbane Broncos for their assistance in compiling these drills.

**To Order Drills Books '1 & 2' visit [www.rlcm.com.au](http://www.rlcm.com.au)**

- |                       |                          |
|-----------------------|--------------------------|
| 1. Dive on Ball Relay | 9. 3 Player Pass Combo   |
| 2. Hand & Vision 1    | 10. 3 Player Pass Combo  |
| 3. Hand & Vision 2    | 11. Speed Diamond        |
| 4. Union Jack         | 12. Arresting The Slide  |
| 5. Middle Man         | 13. "Who Switches"       |
| 6. Onside Passing     | 14. 2 on 1               |
| 7. Line Passing       | 15. Breaking the Defence |
| 8. Rapids             | 16. Pick The Gap         |

	<input type="radio"/> <b>RLCM</b>	1- 29
	<input type="radio"/> <b>Drills Books</b>	1 & 2
	<input type="radio"/> <b>Coach Talk</b>	1 & 2
	<input type="radio"/> <b>Junior Coaching</b>	1

**Order your CD Now Freecall 1800 18 14 14**



VISIT THE WEBSITE TODAY!!

# DRILLS BOOK..( 3 )

## Dive On Ball Relay

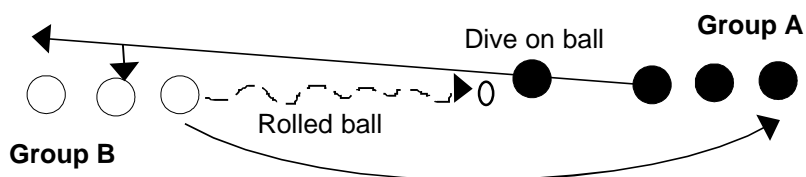

### Setting

3 Players Minimum, 10m X 10m Grid, 1 Football

- Divide players into two equal groups with players in single file and facing each other
- P2 starts the drill by rolling the ball out towards P1
- P1 then runs out and dives on the ball in an attempt to cleanly field the ball, he must urgently return to his feet proceed forward before passing the ball to the next player in Group B (P3)
- The drill continues with each player joining the other group after each play

### Points

- Players should dive 'over' the ball placing their bodies between oncoming defenders and the ball

	<ul style="list-style-type: none"><li>- Need Some New Ideas?</li><li>- Add variety to your training sessions</li><li>- Improve players skill, fitness and performance</li></ul> <p><a href="http://www.rlcm.com.au">www.rlcm.com.au</a></p>
--	---



VISIT THE  
WEBSITE TODAY!!

# DRILLS BOOK..( 3 )

## Hand & Vision 1

Footballs must be kept moving at all times

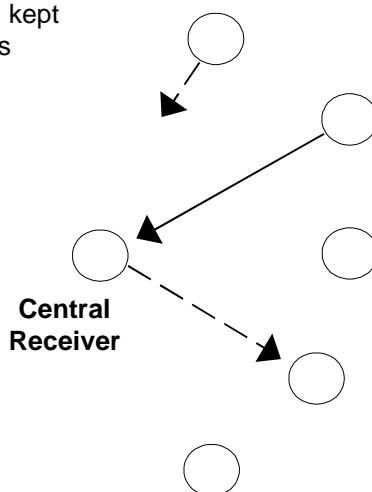

### Setting

5 Players Minimum, Approx 5m X 5m Grid, 2 Footballs

- Five players are positioned in a circular arc, two have footballs
- One player is positioned in the centre of the arc
- One of the players with the football passes to the centre man who must immediately pass to any one of the other players
- As soon as the centre player passes the ball the player in possession of the second football must pass the ball to him
- The drill continues with the centre player catching and passing as quickly as his skills will allow

### Points

- Players in the arc must time passes perfectly
- The arc may contain up to eight players
- The central player may call the name of the receiving player before passing
- Coach should correct passing technique

### Communication

- Players in the arc call the central receiver by name before passing the ball



VISIT THE WEBSITE TODAY!!

# DRILLS BOOK..( 3 )

## Hand & Vision 2

This drill is similar to Hand & Vision 1

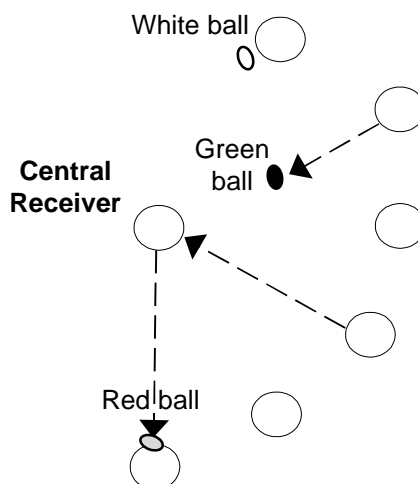

### Setting

5 Players Minimum, Approx 5m X 5m Grid,

3 Different Coloured balls ( balls do not have to be footballs)

- Five players are positioned in a circular arc, three have the coloured ball (e.g. Red White and Green)
- One player is positioned in the centre of the arc
- The centre player begins the drill by calling RED on which the red ball is passed to him
- He then passes the ball to one of the other players without a ball and at the same time calls GREEN, on which the green ball is passed to him
- and so on for the white ball
- The drill now continues with the sequence of colours remaining red, green, white

### Points

- Coach may take control of which coloured ball is passed by calling each pass
- Players must concentrate of the colour of ball they may be in possession of





VISIT THE WEBSITE TODAY!!

# DRILLS BOOK..( 3 ) *Union Jack*

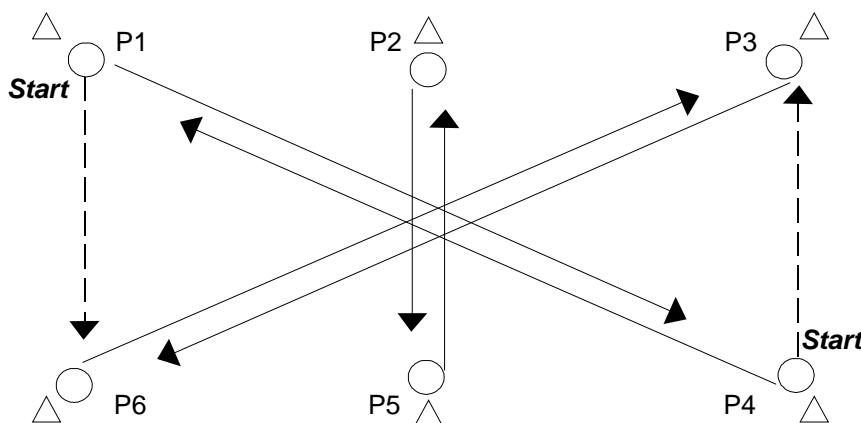

**Setting**

6 Players per group, 10m X 5m Grid, 6 Markers, 2 Footballs per group

- Players position themselves on the markers set around the rectangle grid
- Two players at opposite corners are given footballs (P1 and P4)
- On the start signal players pass the balls in an anti-clockwise direction around the grid
- After each player passes the ball he must run to another marker position and get ready to receive a pass
- P1, P2, P4 and P5 run the diagonal and P3 and P6 run across the grid as shown above

**Points**

- Use only one football until players become familiar with the drill



VISIT THE WEBSITE TODAY!!

# DRILLS BOOK..( 3 ) Middle Man

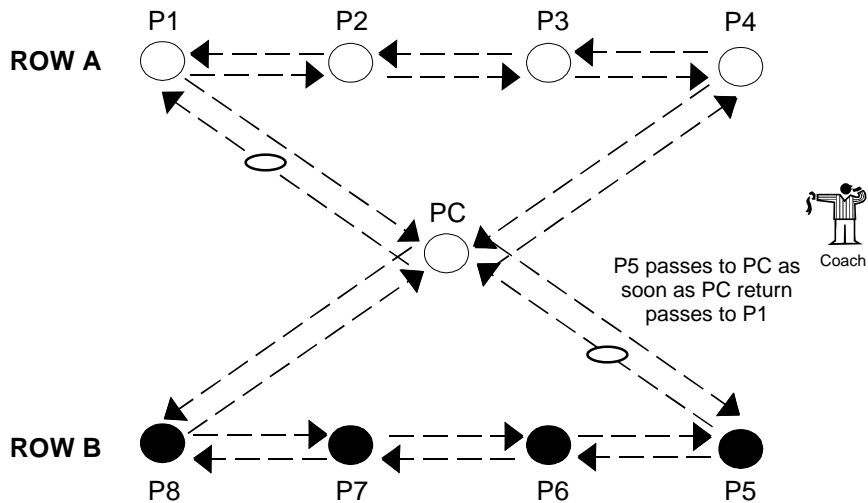

**Setting**

9 Players, 10m X 10m Grid, 5 Markers, 2 Footballs

- P1 in Row A starts the drill by passing to PC who immediately passes the ball back to him
- P1 then passes to P2 who passes the ball to P3 who passes to P4
- P4 then passes to PC who passes straight back
- P4 then passes back down the row to P3 who passes to P2 and then onto P1 etc
  
- Row B joins the drill immediately after PC has passed the ball back to P1
- P5 calls out PC's name to begin the involvement, he must turn and receive a pass from P5
- PC returns the pass to P5 who then passes to P6 and so on down the row as described above

**Points**

- Timing of the pass to PC is crucial
- Coach should study players passing and catching technique
- Rotate Player in centre regularly



VISIT THE WEBSITE TODAY!!

# DRILLS BOOK..( 3 )

## Onside Passing

Diagram Stage 2

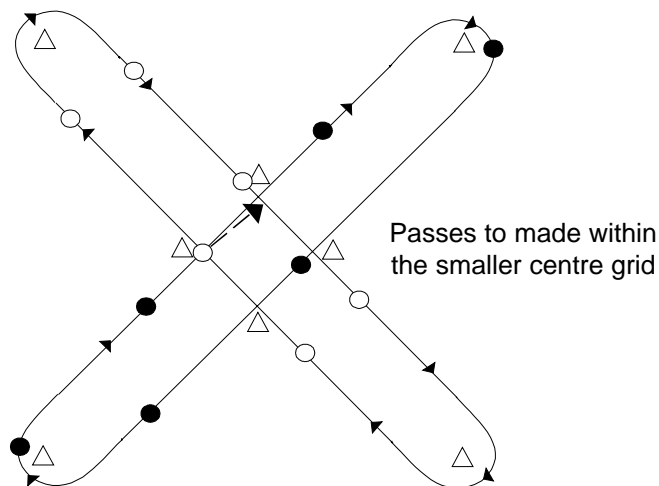

### Setting

6 Players minimum, 10m X 10m Grid minimum, 8 Markers, 2 Footballs

- In the centre of the 10m grid mark out a smaller 2-3m grid

### Stage 1

- Start with two groups at opposite corners of the 10m grid
- The first player in one of the groups runs towards the other group, as he reaches the second marker of the smaller grid, he passes laterally (not forward) to the player approaching from the opposite group who has timed his run to receive the pass
- The player now in possession passes to the second player of the first group and the drill continues

### Stage 2

- Divide players into 4 groups and position a group on each corner
- The drill works as above but there is now 'traffic' to avoid as four players converge on the smaller grid

### Points

- Change running lines so passes are made in the opposite direction
- Keep score by counting the number of passes in a set time or until a ball is dropped

# Line Passing

VISIT THE WEBSITE TODAY!!

Stage 1

## DRILLS BOOK..( 3 )

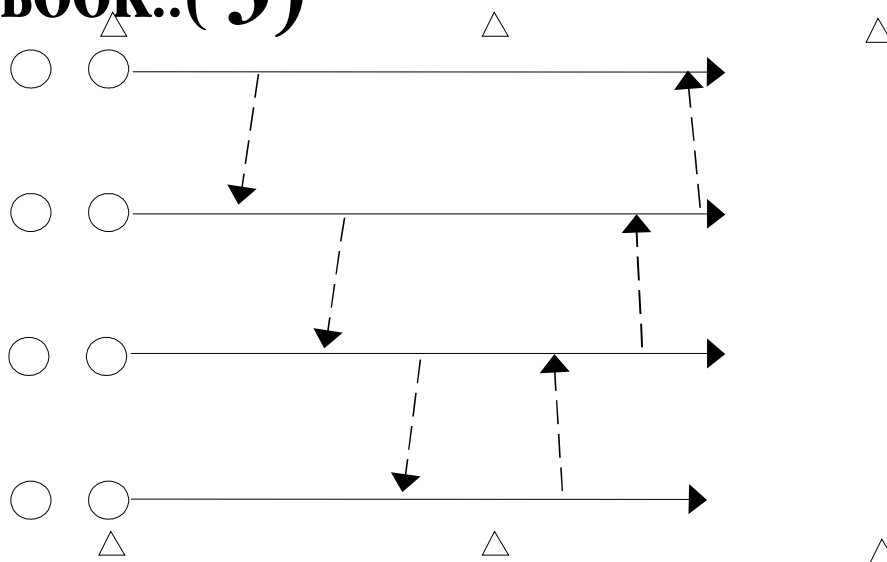

**Setting**

Groups of 4, 20m X 15m Channel, 8 Markers, 1 Football per group

- Divid players into groups of 4 and have them line up at one end of channel

**Stage 1**

- Each team runs to the end of the channel passing back and forth along the way
- When the first group reaches the end of the channel the next group sets off
- Once all groups have run through, they repeat the exercise moving back down the channel in the opposite direction

**Stage 2**

- The groups now do not wait at the ends of the channel, they continuously move back and forth passing along the line while negotiating 'traffic'
- Players on the ends of the groups should swap with the middle players at the end of each run

**Stage 3**

- Groups are positioned at each end of the channel and in relay fashion, using one football perform the exercise at 3/4 pace

**Stage 4**

- Same as stage 3 but now run at full pace
- Players may either pop the ball at the end of the channel or place it on the ground for a running pick-up by the next group

www.rlcm.com.au



VISIT THE WEBSITE TODAY!!

# DRILLS BOOK..( 3 )

## Rapids

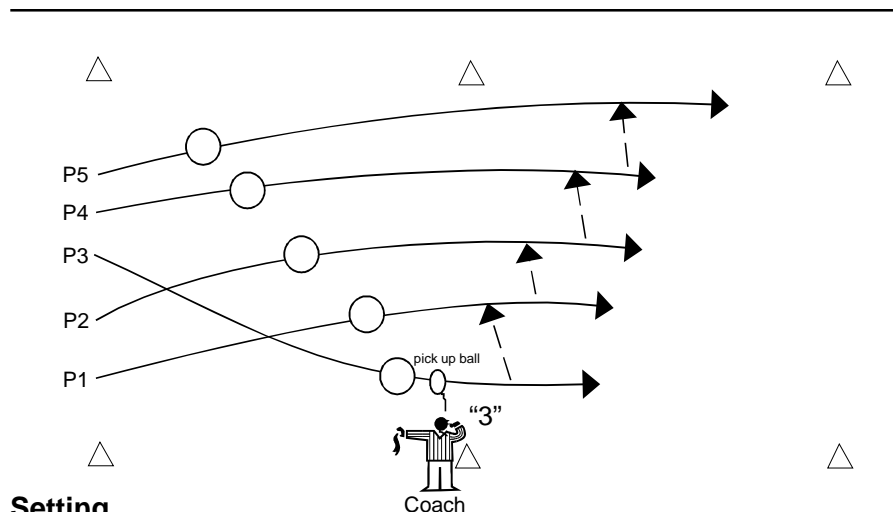

### Setting

2-5 players per group, 20m X 20m grid, 6 markers, 1 Football

- The diagram above is set with 5 players per group
- the 5 players from group one are positioned in any formation on the start line
- Each player is given a number
- The coach places the football on the ground in front of the group (placement should change with each exercise or the ball could be rolled on the ground)
- The coach calls a number to begin the drill
- The numbered player must retrieve the ball
- The remaining players must move to one side and into support positions
- The player retrieving the ball should call 'My Ball' and then pick the ball up on the run before starting a passing movement where all players must get a touch of the football
- Run all groups to the end of the grid and repeat the drill coming back in the opposite direction

### Points

- For variation have players lying on their stomachs and facing away from the football, call left or right to indicate the direction



VISIT THE  
WEBSITE TODAY!!

## DRILLS BOOK..( 3 )

### 4 Players Pass Combo

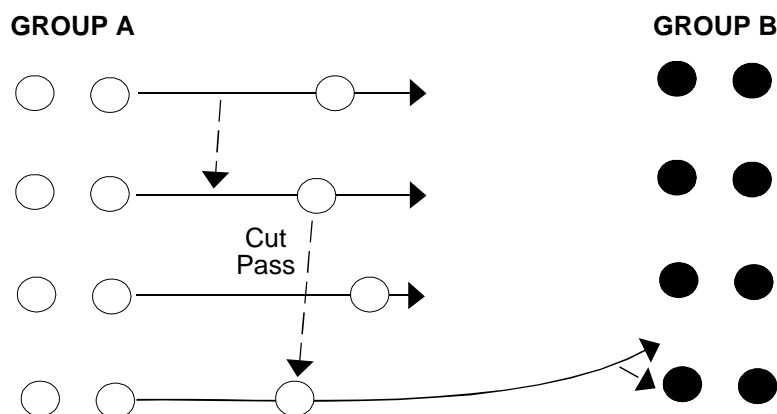

#### Setting

Groups of 4-5, 30m X 15m Grid, 4 Markers, 1 Football

- This is a common 4 player catching and passing drill
- Organise players into groups of 4 and position them at opposite ends of a 20m grid, the grid should only be 15m wide and lesser for younger players
- P1 leads off down the grid and passes to P2
- P2 holds the ball long enough for P3 to burst through on a straight run as if he is going to take a short pass
- P2 then throws a cut pass behind the back of P3 who has become a dummy runner to P4 who receives the ball while running at top pace and maintains speed to the end of the grid
- P4 then pops a pass to the end player of Group B and the drill continues

#### Points

- Drill is designed to be performed at full pace
- Variations can be adapted to include switches, double cuts, dummy passes, loop passes etc however pace and intensity should be maintained at all times



VISIT THE WEBSITE TODAY!!

# DRILLS BOOK..( 3)

## Speed Diamond

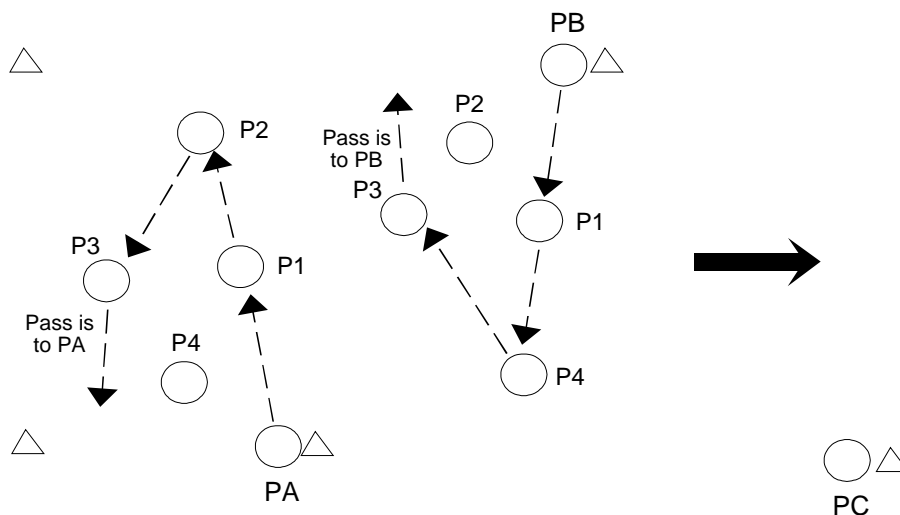

### Setting

8 Players (4 at each starting point and 4 in transfer group) , Approx 40m X 15m Channel, 8 Markers, 4 Footballs

- Position 4 players PA, PB, PC, PD on the side of the channel, these players are distributors and each has a football (the above diagram only shows 3)
- The transfers group is positioned as a group of 4 and their positioning is critical
- The transfer group moves down the channel
- PA passes to P1 who makes a quick lateral pass to P2
- P2 makes an inside pass to P3 who passes the ball back to PA (the diagram shows the pass from P3 going to no one however as the players are moving forward P3 will be almost opposite PA)
- The drill continues from the opposite side with PB passing the ball to P1

### Points

- A high level of ball skills is required to perform this drill correctly



VISIT THE WEBSITE TODAY!!

# DRILLS BOOK..( 3)

## Arresting The Slide

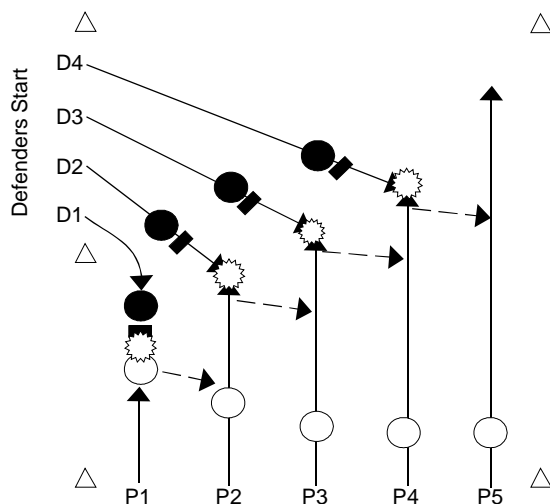

### Setting

5 attackers and 4 defenders with pads, Approx 15m X 15m, 4 hit pads, 5 markers, 1 football

- A draw and pass drill designed to teach players to fix a defender before passing the ball
- Position attackers and defenders with hit pads on the marked grid as shown
- The attacker nearest to the defender starts the drill with the football
- On the start signal the attackers move down the grid and the attacker in possession runs towards the inside shoulder of the first defender, when close he passes the ball and then proceeds to 'take out' the defender
- The new attacker now in possession does the same movement with the next defender and the drill continues down the line
- The aim of the drill is for each defender to be effectively fixed and properly hindered for him not be in a position to get near the attacker who has the overlap

### Points

- Rotate players are each exercise between defender and attacker and also in an anti clockwise rotation





VISIT THE  
WEBSITE TODAY!!

# DRILLS BOOK..(3) "Who Switches"

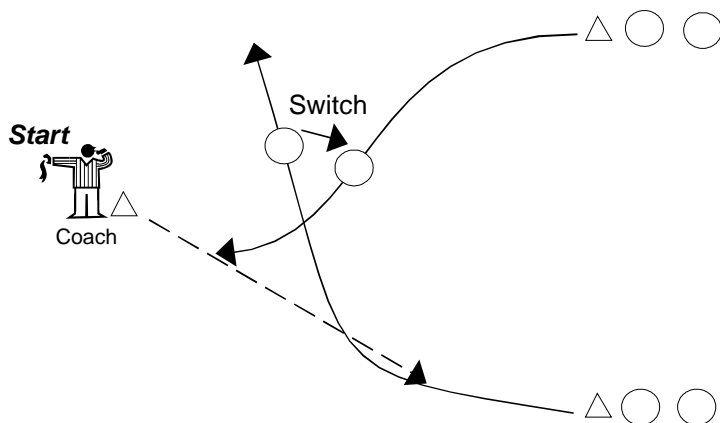

## Setting

3 Players Minimum, 10m Triangle, 3-4 Markers, 1-2 Footballs

- A switch pass drill with a difference
- Players form pairs and position themselves on markers which are set 10 metres apart
- The coach is positioned on a marker in front of the players and should have 1 or 2 footballs
- On the coach's command the first pair move forward
- The coach passes the ball to either player
- When the receiver catches the ball both players must react and work a switch
- The coach can be used as a stationary defender
- The ball is returned to the coach after the switch has been performed

## Points

- Position another marker 10 metres behind the coach, players must accelerate and perform 1 standard pass before the marker
- Allow players to perform dummy switches
- Coach can hold the pass or pass the ball early to any of the players running lines



VISIT THE WEBSITE TODAY!!

# DRILLS BOOK..( 3 )

## 2 on 1

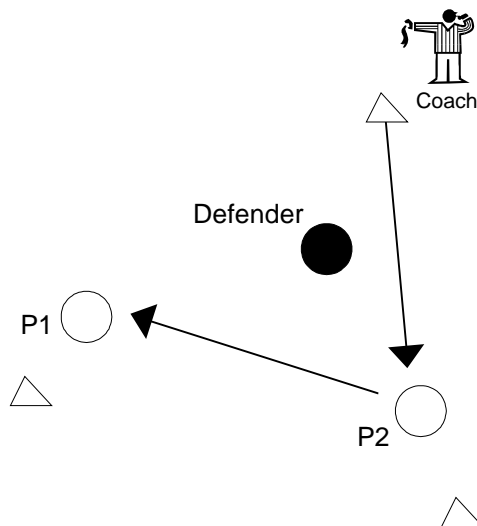

### Setting

3-4 Players Minimum, 10m Triangle, 3 Markers, 1 Football

- Set markers out approx 10 metres part in a triangle pattern
- Drill is designed to be performed at full pace
- The coach positions himself on one of the markers
- The players form two groups and are positioned on the remaining two markers
- One player is nominated as the marker
- P1 and P2 move off in the direction of the coach, the coach immediately passes the ball to one of the players
- The defender must attempt to shut down the attack by performing a two handed tag on the player in possession of the football
- Off-side passes are permitted, as players are encouraged to move and find space

### Points

- Add another defender to make it a 2 v 2 situation, a larger area will be required



VISIT THE WEBSITE TODAY!!

# DRILLS BOOK..( 3 )

## Breaking The Defence

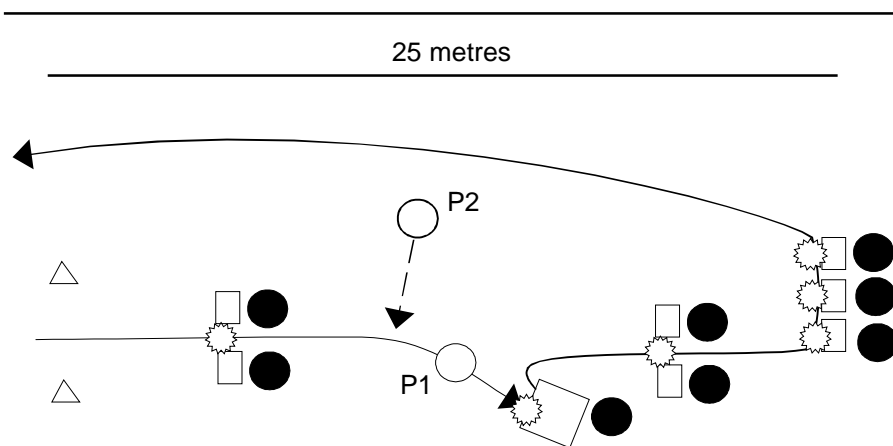

### Setting

10 Players Minimum, Approx 15m X 25m Channel,  
7 Hit Pads, 1 Tackle Bag, 2 Markers, 1-3 Football

- Set up equipment as shown in diagram
- P1 runs out from the start position and into a contact situation with the first two pad holders
- After busting through he then receives a pass from P2 and moves towards the tackle bag
- Using well balanced technique he hits and spins away from the bag and then with the ball held close to the chest the player proceeds to bust through the next two pads
- The player then aims and with a lesser degree of contact hits the pads off centre and rolls out
- P1 returns to the start area popping a pass to P2 who regains possession the commence the next exercise

### Points

- Coach should emphasise the importance of ball carry whilst in traffic and ball security in the tackle area
- Players should receive pass from both left and right sides



VISIT THE  
WEBSITE TODAY!!

## DRILLS BOOK..( 3 )

# RLCM Drills

## *Basic Training Drills*

RLCM wish to acknowledge the New South Wales Rugby League Academy and Coaching and Development Manager Martin Meredith for their kind support in allowing RLCM to reproduce these drills from their Official Rugby League Coaches Handbook (Printed 2001).

The coaching drills used in this issue are designed for skill acquisition for players between the ages of 5 to 14 years. Players will best acquire the skills of rugby league if given a fun environment full of activities, which best fit, the physical capabilities of each age group.

To increase the difficulty of these drills, coaches should consider:

1. Decreasing space of drill
2. Decreasing the time available to perform the skill
3. Increase the physical presence within the drill

[Published with the authority of the NSWRL Academy]

	<input type="radio"/> <b>RLCM</b>	1- 29
	<input type="radio"/> <b>Drills Books</b>	1 & 2
	<input type="radio"/> <b>Coach Talk</b>	1 & 2
	<input type="radio"/> <b>Junior Coaching</b>	1
<b>Order your CD Now Freecall 1800 18 14 14</b>		



VISIT THE  
WEBSITE TODAY!!

# DRILLS BOOK..(3) **FROZEN TAG**

---

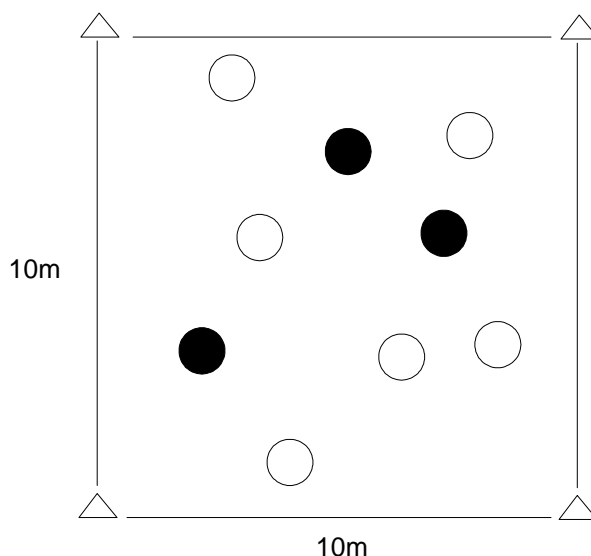

### Setting

9 Players minimum, 10 x 10 Metre Grid, 4 markers

- The group is divided into three equal teams
- 1 team is nominated as the chasers, the other two teams must avoid being tagged (two handed grab) by Team 1
- If a player is tagged he becomes a frozen player and must stand still with his legs apart
- Team members of the frozen player must attempt to 'defrost' the player by crawling between his legs
- Once all players have been frozen by Team 1, the teams swap roles so Team 2 would become the chasers
- The team the can freeze the opposition in the shortest amount of time wins



VISIT THE WEBSITE TODAY!!

# DRILLS BOOK..( 3 )

## ***CORNER TAG BALL***

---

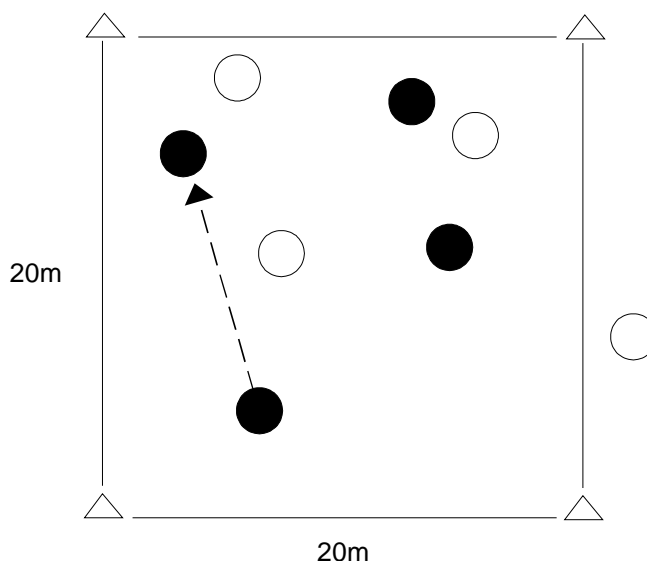

### **Setting**

8 Players minimum, 20 x 20 Metre Grid, 4 markers

- Divide group into two teams
- Players in Team 1 must attempt to tag players in Team 2
- Team 2 must avoid being tagged
- Team 1 may run anywhere within the grid passing the ball to each other but may not run when in possession of the ball
- When attempting to tag a player they may only take one step and must hold the ball in two hands
- Once a player has been tagged he must move outside the grid
- Each time the ball is dropped by Team 1 one player from Team 2 may return to the game
- The coach should designate a period of time, at the end of this time the number of tagged players are counted



VISIT THE  
WEBSITE TODAY!!

## DRILLS BOOK..( 3 )

# ***HOW MANY PASSES***

---

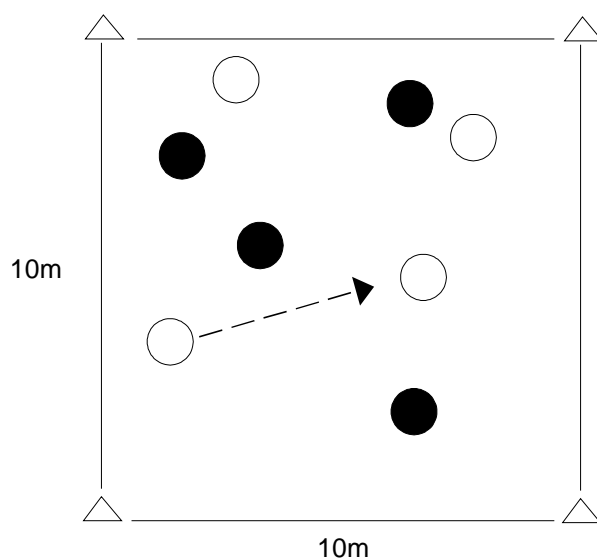

### **Setting**

8 Players minimum, 10 x 10 Metre Grid, 4 markers

- Divide group into two teams
- Each team gets an equal amount of time to make as many passes as possible
- The player with the ball must stand still and find a support player who moves into position to receive a pass
- The opposition team must attempt to intercept the ball or knock down the pass



VISIT THE WEBSITE TODAY!!

# DRILLS BOOK..( 3 )

## TAIL CHASE

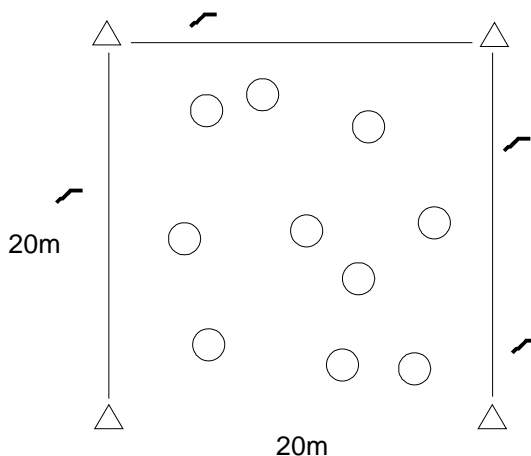

### Setting

5 Players Minimum, Approx 20m X 20m Grid, 1 sock per player

- All players start the game inside the grid with one football sock placed in the back of their shorts
- On coaches command players attempt to snatch socks from other players and store them in a pile on the edge of the grid
- Players who lose their sock continue to snatch socks from other players
- When all socks have been snatched, count who has the most

<p><b>COACH</b> Enquire about the RLCM CD-Rom For Your Club <a href="http://www.rlcm.com.au">www.rlcm.com.au</a></p>	<p><i>Talk</i> <b>YEARBOOKS</b></p> <p>Delve into the minds of leading NRL Coaches. Read about philosophies, trends, training tips and techniques. These books are an extensive &amp; revealing look at the world of Rugby League Coaching.</p>
--	---





VISIT THE  
WEBSITE TODAY!!

## DRILLS BOOK..( 3 )

# CHAIN TAG

---

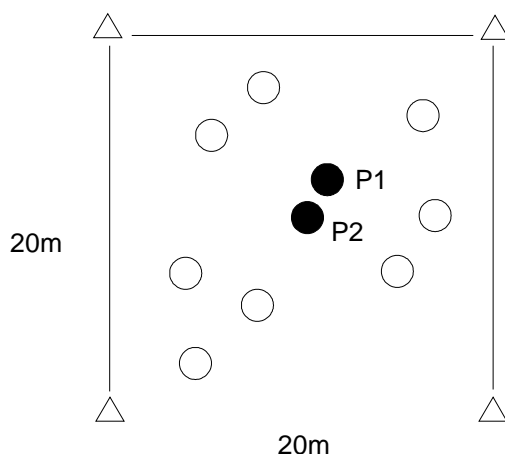

### Setting

5 Players Minimum, Approx 20m X 20m Grid

- All players start the game inside the grid
- 2 players (P1 & P2) join hands and are nominated as chasers
- P1 & P2 must attempt to tag other players
- Once a player has been tagged he must then join the chain
- The chain grows until all players have been tagged



VISIT THE  
WEBSITE TODAY!!

## DRILLS BOOK..( 3)

# ZIG ZAG TAG

---

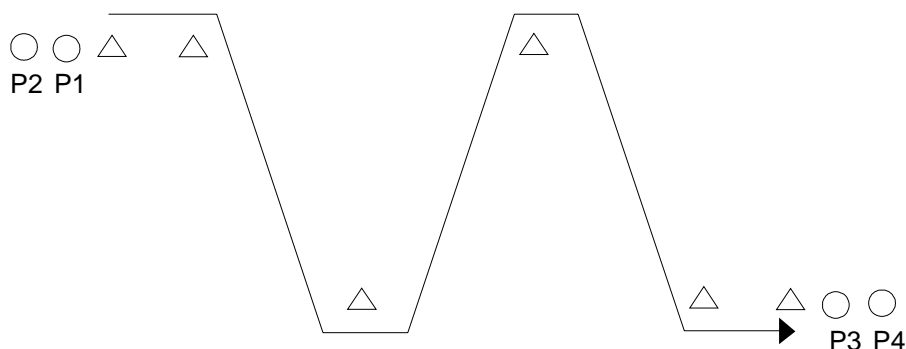

### Setting

4 Players Minimum, 6 markers

- Set up markers as shown above
- Players line up in pairs with equal numbers at each end of the grid, all players carry a football
- On coaches command P1 runs the marked path, P2 starts once P1 steps the first marker
- P2 chases P1 and attempts to tag P1 with the ball
- When P1 and P2 reach the other end of the grid P3 and P4 start off back through the grid
- The chaser must tag the leader as many times as possible



VISIT THE  
WEBSITE TODAY!!

## DRILLS BOOK..( 3 )

# ***EVASION MARKERS***

---

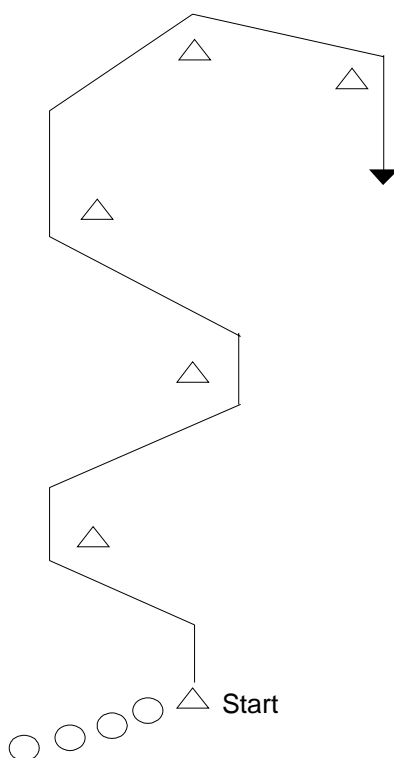

### **Setting**

5 Players Minimum, 5 markers

- Set up markers as shown above
- Players run through the grid stepping at each one
- Initially start the drill at half pace
- Progress the drill by increasing pace
- Then introduce a football to be carried and handed off at the end of each run through



VISIT THE  
WEBSITE TODAY!!

# DRILLS BOOK..( 3)

## PURSUIT

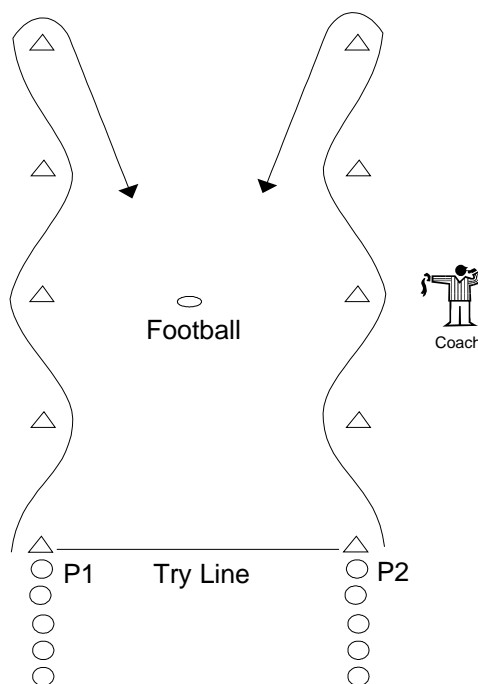

### Setting

8 Players Minimum, 10 markers

- Set up markers as shown above
- Players line up in two equal groups behind start markers
- On coaches P1 & P2 run down the grid in zig zag fashion between markers
- After rounded the last witches hat, players run down the centre of corridor
- Both players attempting to pick up the football on the run and then score a try
- The player without the ball attempts to tag the player now in possession of the ball with two hands
- The next two players then continue the drill
- Add points for a try to introduce a game aspect
- Team members should encourage the runner



VISIT THE WEBSITE TODAY!!

# DRILLS BOOK..( 3)

## 2 ON 1

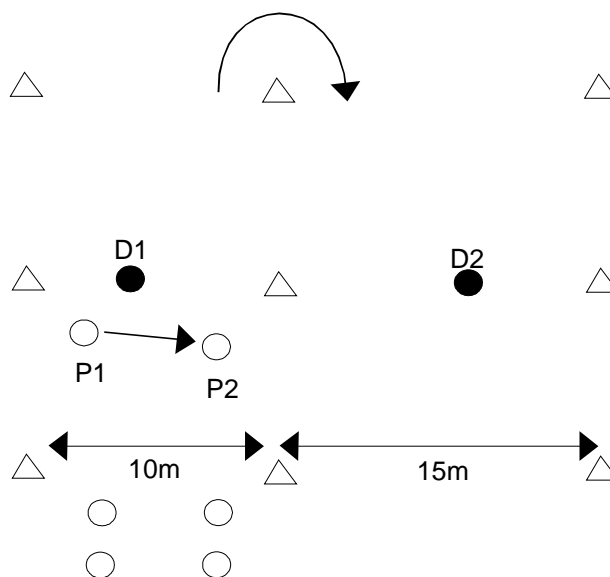

### Setting

6 Players Minimum, 15 x 25 Metre Grid, 9 markers

- Two columns are set up one wider than the other
- Attacking players line up in pairs with 1 defender in each column positioned on marker
- The first pair (P1 and P2) run down the grid attempting a draw and pass on the defender
- P1 and P2 then round the end marker and return down the second column which is wider than the first
- Once again they attempt a draw and pass on the defender
- Defenders can only move left and right and not forward and back
- Progress by adding more defenders into the columns so attacking players must perform consecutive plays



VISIT THE WEBSITE TODAY!!

# DRILLS BOOK..( 3 )

## 3 ON 2

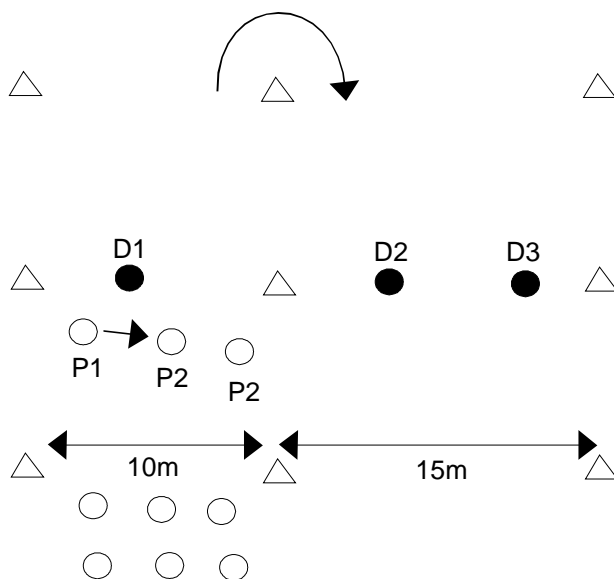

### Setting

9 Players Minimum, 15 x 25 Metre Grid, 9 markers

- Continuation from 2 on 1
- Attacking players line up in groups of 3 with 1 defender in the first column and 2 defenders in the second column
- The first trio (P1, P2 & P3) run down the grid attempting a draw and pass on the defender
- The trio then rounds the end marker and returns down the second column which is wider than the first
- Once again the trio attempts a draw and pass but now there are 2 defenders
- Defenders can only move left and right and not forward and back



VISIT THE WEBSITE TODAY!!

# DRILLS BOOK..( 3 )

## 3 ON 2 (OPTION)

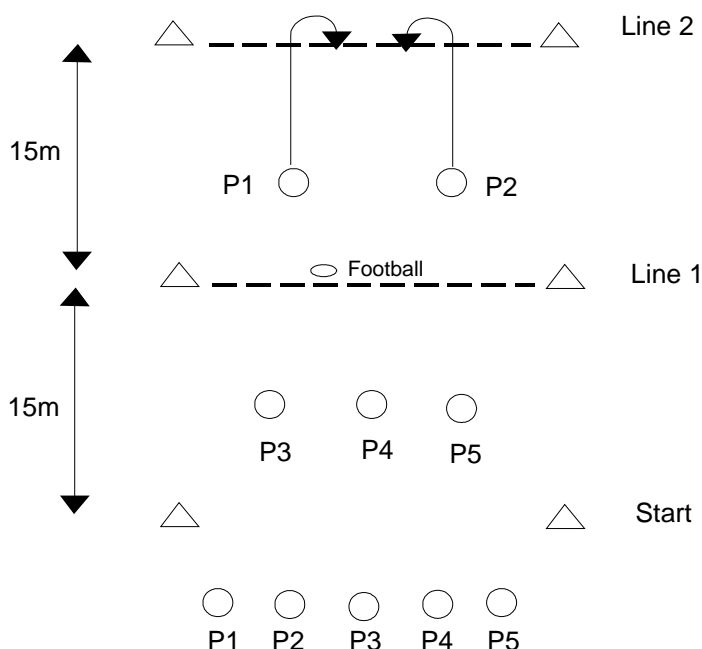

### Setting

5 Players Minimum, 15 x 30 Metre Grid, 6 markers

- Players line across grid in a group of 5
- The first 2 players (P1 and P2) make a pair , and the other players make up a trio
- P1 and P2 run up the grid passing back and fourth
- When they reach the first set of markers the players with the ball places it on the ground
- P1 and P2 then proceed to line 2 where they must touch the ground, turn and then become defenders
- Once the first group has placed the ball P3, P4 and P5 proceed down the grid
- P3, P4 and P5 must pick up the ball and then attempt to beat the two defenders with a 3 on 2 play



VISIT THE WEBSITE TODAY!!

# DRILLS BOOK..( 3 )

## ***SUPPORT SCURRY***

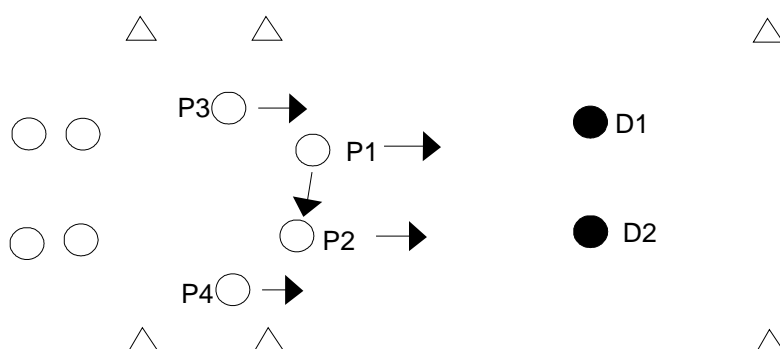

### Setting

8 Players Minimum, 10 markers

- P1 and P2 run down the grid passing the ball back and fourth
- Once they reach the second set of markers P3 and P4 run down the grid
- P3 & P4 must join P1 and P2 in a support position creating a 4 on 2 situation on D1 and D2
- The group now consisting of 4 players attempts to score a try
- P1 and P2 become defenders and the drill continues

	<input type="radio"/> <b>RLCM</b>	1 - 29
	<input type="radio"/> <b>Drills Books</b>	1 & 2
	<input type="radio"/> <b>Coach Talk</b>	1 & 2
	<input type="radio"/> <b>Junior Coaching</b>	1
<b>Order your CD Now Freecall 1800 18 14 14</b>		





VISIT THE WEBSITE TODAY!!

# DRILLS BOOK..( 3 )

## ***FRONT ON TACKLING***

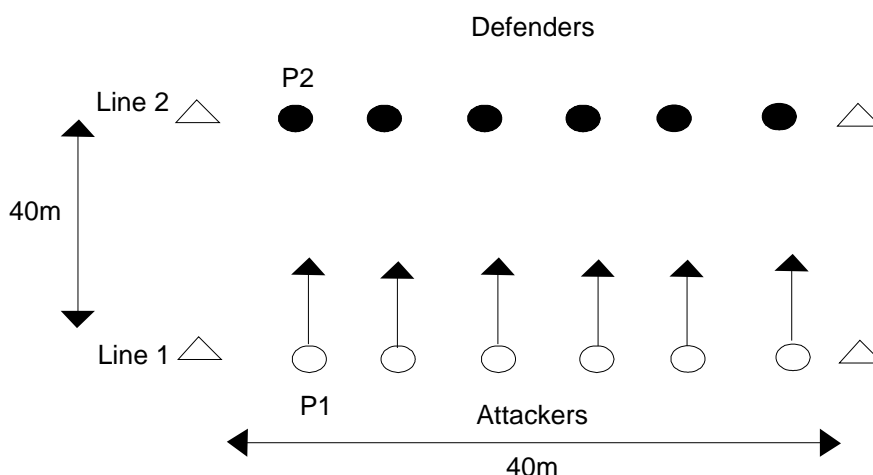

### **Setting**

10 x 40 Metre Grid, 4 markers

- Players make two lines facing each other
- Players in line 1 (P1) carry a football, line 2 (P2) are defenders
- P1 advances towards P2, who, standing in a front on position makes a chest to chest contact with P1
- P2's arms extend around P1 to secure a strong hold on the attackers back
- P1 then uses his momentum to force both players to the ground
- Repeat the tackle using alternate shoulders and then swap attackers and defenders



VISIT THE WEBSITE TODAY!!

# DRILLS BOOK..( 3 )

## TIE THE CALF

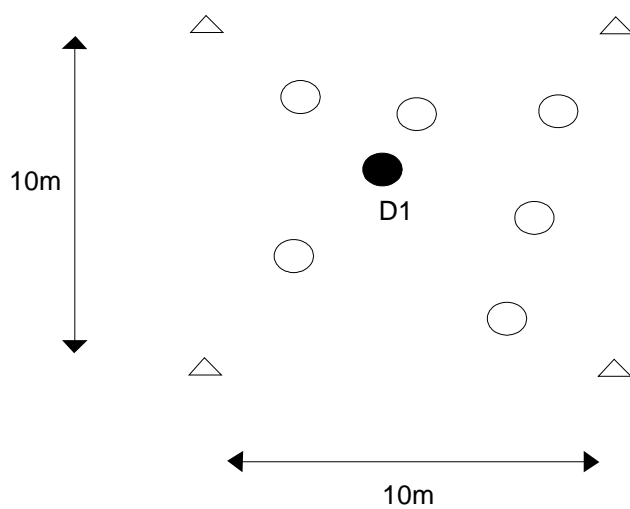

### Setting

7 Players minimum, 10 x 10 Metre Grid, 4 markers

- All Players start within the grid, 1 player (D1) is nominated as a defender
- D1 must attempt to tackle and force to the ground and onto their backs as many players as possible in 1 minute
- The defender gets 1 point for each grounded player
- Continue the drill so all players have a turn at being defender



www.rlcm.com.au

Coaching Manuals, Drills Books, Junior Coaching, Coaching Newsletter



VISIT THE WEBSITE TODAY!!

# DRILLS BOOK..( 3)

## MIRROR MIRROR

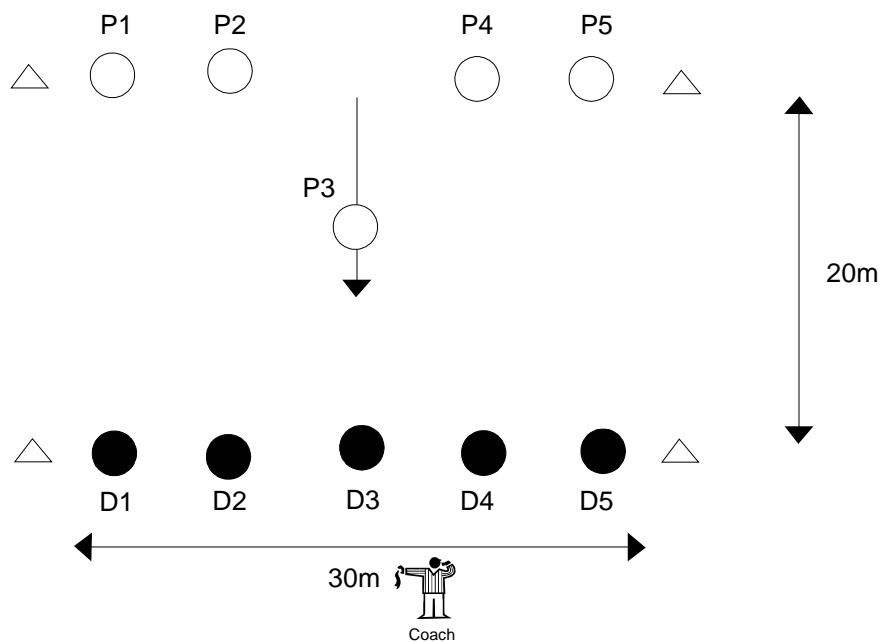

### Setting

8 Players minimum, 30 x 20 Metre Grid, 4 markers

- Divide group into two equal teams (attackers and defenders)
- Teams line up opposite and facing each other
- Each attacking player is given a number
- The drill starts with the coach directing the attacking team to move left or right by raising his arm
- The defending team must adjust and nominate the attacker they are marking
- The coach calls a number (e.g 3) and player 3 must approach the defence with the opposing players making the tackle
- A ruck is formed, and play continues by a dummy half moving in and passing to his attacking line
- All players must adjust
- Each team has possession for six tackles then change roles



VISIT THE  
WEBSITE TODAY!!

## DRILLS BOOK..( 3 )

# RLCM Drills

## *Training Drills*

Compiled by Glenn Bayliss

RLCM wish to acknowledge Glenn Bayliss, QRL Southern Division Development Officer and ARL High Performance Coach for his assistance and time in compiling the following drills.

The drills featured are designed for both Junior and Senior Levels of the game.

Variations and progressions can be added by the coach to make the drill more difficult.



**e-books**  
*Electronic Books*

### ***What is a RLCM e-book?***

An RLCM e-book is a book that is saved as a file on your computer. This same book you are reading now can be sent directly to your computer by e-mail. Benefits of e-books are (1) storing the book for future reference, (2) easily forwarding and sharing the books with other coaches, and (3) printing multiple copies for all coaches in your club. Visit our website today for more information.

**All 28 RLCM Coaching  
Books are available**

**[www.rlcm.com.au](http://www.rlcm.com.au)**



VISIT THE  
WEBSITE TODAY!!

## DRILLS BOOK..( 3)

# Clap & Catch

---

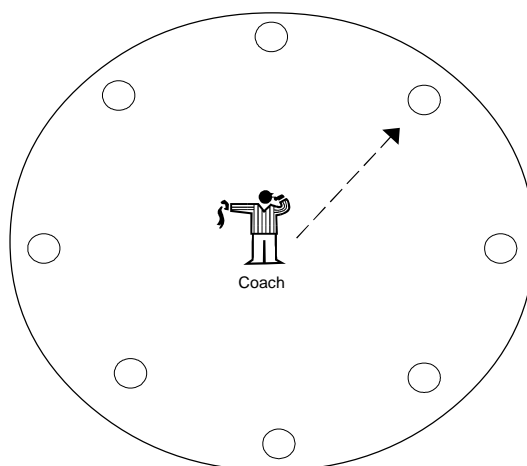

### SET UP:

Minimum 5 players per group, players form circle around the coach.

### COACHING POINTS:

Reaction drill that is fun and switches the mind on, good for warm up or start of session, gets players paying attention.

### THE DRILL:

- Coach to pass the ball to a receiver
- The receiver must clap his hands before catching the ball.
- The player catches the ball and passes back to coach
- Coach passes the ball to the next receiver

### RULES:

- If the player does not clap his hands before catching the ball that player is out of the game and sits down.
- If the coach throws a dummy pass to the player and he claps his hands, but the ball does not come, the player is also out.

### POINTS:

Coach throws his passes to any player in the circle to keep them all switched on.  
(Every 3 or 4 passes include a dummy pass)



VISIT THE WEBSITE TODAY!!

# DRILLS BOOK..( 3)

## Grenade

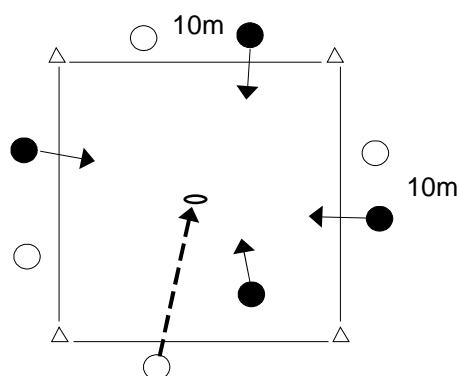

**SET UP:**

Grid 10m x 10m, minimum 6 players, divide players into 2 teams.

**COACHING POINTS:**

Players should communicate with each other as to how they are covering the ball. Players should position themselves each side of the ball and expecting it to come their way.

**THE DRILL:**

- Similar to Bouncer Ball Tennis.
- Both teams move around outside the grid, one player has a football.
- The player with the ball throws the ball in the air as high as he wishes and into the grid.
- The opposing team rushes into the grid, allows the ball to bounce, and then must catch the ball before it hits the ground for a second time.
- Once the ball is caught the player then throws it in the air the team must retreat out of the grid.
- The first team comes back into the grid and they must catch the ball after the first bounce.... and the drill continues

**RULES:**

If not caught on the first bounce the other team gets a point or the closest player is eliminated.

For younger players play to 11 points without elimination.

**BENEFITS:**

Communication between players, reaction, footwork, fun, fitness.



VISIT THE  
WEBSITE TODAY!!

## DRILLS BOOK..( 3)

# Tag Belt Boxing

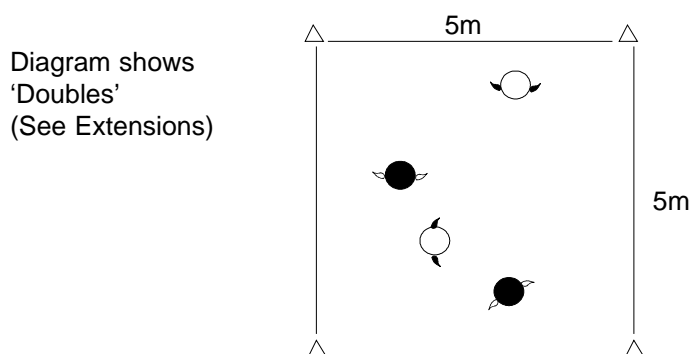

### SET UP:

Grid 5m x 5m, two players per grid.

Each player has flag belt with colours on each side on hip.

### COACHING POINT:

Footwork - moving forward and backwards, changing bodyweight from side to side, fend other players off with hands, the game can become physical, no wrestling allowed.

A demanding drill that improves fitness.

### THE DRILL:

- Using footwork players attempt to remove flags from opponent.
- Players must prevent having their own flags removed.
- First player to have two flags removed is out.
- No winner after two minutes stop and declare winner. (player who attacked more)

### EXTENSIONS:

- **DOUBLES** - Two players with red flags, two players with white flags.
- **TEAMS** - Two teams 4 - 6 Players each side (10m x 10m grid)
- **WATCH YOUR TAIL** (10m x 10m grid)
  - Each player has one flag belt as a tail.
  - Once the tail is gone the player is eliminated.
- Play for 1 - 3 minutes

### BENEFIT:

Vision, Footwork, Fitness, Teamwork, Fun, Communication



VISIT THE WEBSITE TODAY!!

## DRILLS BOOK..( 3)

# Bouncer Ball Tennis

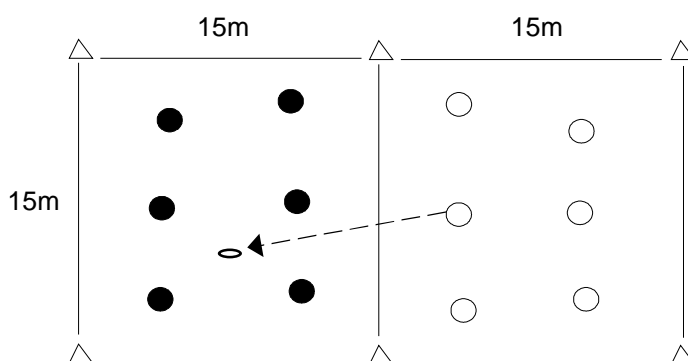

### SET UP:

Grid 15m x 30m, 8 to 12 players - depends on the ages of the players, divide players into 2 teams.

### COACHING POINT:

The drill is for players to react to a situation, adjusting to the different bounce of the ball.

### THE DRILL:

- Rules same as Kick Tennis
- One ball per grid with the ball kicked bewteen players
- Ball is kicked in air over 2 metres high, instead of catching the ball on the full as in kick tennis, players let the ball bounce.
- The players have to move in towards the ball, let it hit the ground, adjust, and then attempt to catch the ball before it hits the ground for the second time.

### RULES:

- Use the drill as an Elimination Game;
- Once the ball bounces, if is not caught before the second bounce the player closest to the ball is eliminated.
- For younger players 7 - 12 years have a point score game up to 11 points to keep them all playing.

### BENEFITS:

Footwork, sidestepping, changing direction, reaction time, catching skills.



# Buddy Up Touch

VISIT THE  
WEBSITE TODAY!!

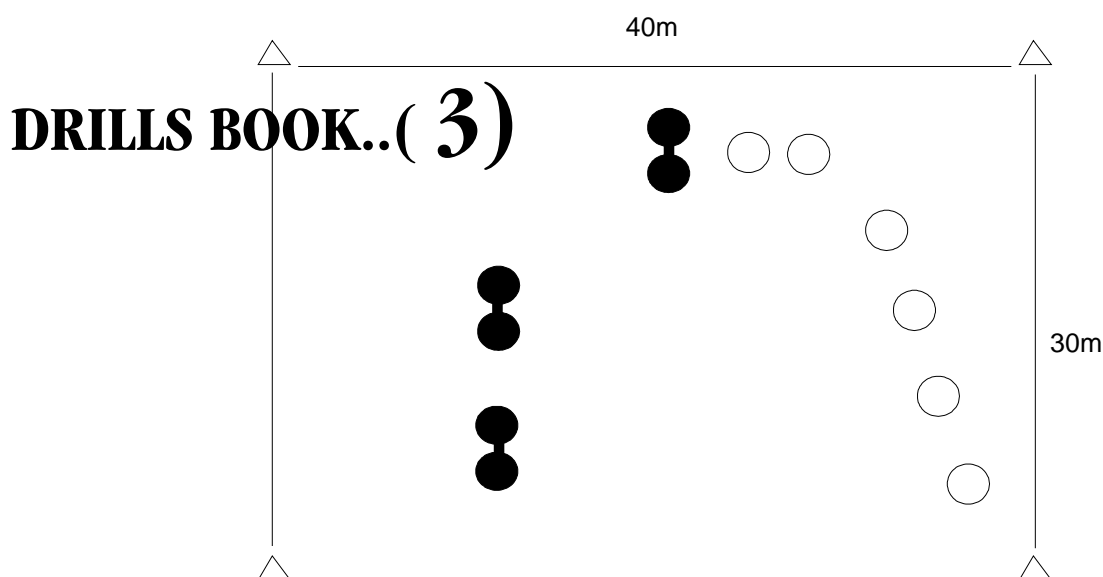

## SET UP:

Grid 30m x 40m long, 6 to 8 players per side.

Divide group into 2 teams, attackers and defenders, coach may use left hand side against right hand side, defending players pair up and hold hands or connect with agility belts

## THE DRILL:

- A Touch Game with 4 tackles no kicks.
- Attacking team taps ball to start the game, defending players are linked in pairs
- If a break is made a defending pair can break hands and chase immediately.
- After 4 tackles swap over.
- Make a game of it, first to 7 tries wins the game.

## COACHING POINTS:

This drill is based on learning to communicate.

Defensive players are forced to scramble, communicate and make snap decisions on whether to go up and in or up and out together.

## DEFENDERS

Defending players hold hands or velco straps/belts

Players must move up and adjust together

The key is for the two defenders to remain holding hands and communicate continually.

Tackles are only a touch situation

## ATTACKERS

Try to isolate defenders by moving inside a defending pair of players and throwing a pass to a support player outside the defending pair of players.

## POINTS:

The players linked together should be the players that are next to each other on the field during a game and have to develop communications.

eg:- Front rower and second rower together

- Wingers and centres together

www.rlcm.com.au



VISIT THE WEBSITE TODAY!!

# DRILLS BOOK..( 3)

## Restart

Encouraging players to take the right options, including exploration of kick options when a try is not on by putting a kick into the in-goal area, so they can get the ball back again.

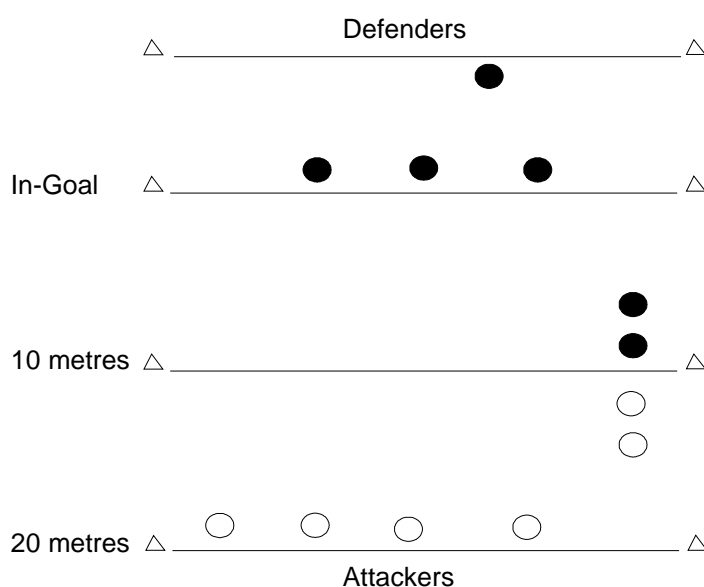

**SET UP:**

Grid 30m + in-goal x 40m.

Team of 6 defending players against a team of 4, 5 or 6 attacking players.

**THE DRILL:**

- The idea is to see how long the attacking team can control the ball, by scoring tries, or by kicking into the in goal area and receiving restarts.
- Play starts with defenders on the tryline, attackers playing the ball on the 10 metre line. (No attacker deeper then the 20 metre line).
- The aim of the attacking side is to attack the line and score within 4 tackles
- Two ways of scoring a try
- Passing to create space to score a try or at any stage use a kick to score [Grubber, Chip Kick into goal, High kick, Bomb]
- Whenever the attacking team kicks into the in-goal, and the defending team falls on it, the tackle count starts again, with the attacking side at tackle one.



VISIT THE  
WEBSITE TODAY!!

## DRILLS BOOK..( 3)

### *Restart continued*

#### **POINTS:**

The ball goes to the defending side to be attackers if:

- The attacking side knocks on.
- The attackers kick the ball dead.
- A forward pass is thrown.
- Defending player catches the ball on the full in the in-goal area.

The defending team then changes places with the attackers or the defender recovering the kick makes his way out from the in-goal

Coach decides how he wants the defence structured.

#### **RULES:**

If a defender catches the ball in the in-goal from a kick, the attacking side loses possession and they become defenders.

If a kick is caught on the full outside of the tryline, it is classed as a turnover and the ball is turned over to the defending side, who now become the attackers.

Two handed touch, flag belts or proper tackles can be used by the defensive team. (decided by coach)

The kick can occur on any tackle, but one of the aims of the drill is to instil the art of patience, explore options, and to develop the correct option when attacking the line.

A sample play could be 3 tackles and kick into the in-goal, looking to get the ball back from a restart, but if a defender brings the ball back into the field of play the defenders then become the attackers.

Rotate both defending and attacking teams from sideline reserve players.

Allocate 1 point per try and play up to 7 or 11 points



VISIT THE  
WEBSITE TODAY!!

## DRILLS BOOK..( 3)

# Directed Defence

Most defensive patterns these days can change once the ABC defenders get to the advantage line, whereby they may have a up and in or a up and out defence.

Players must realise that defensive structure does change during a game, even to the point, when moving up off your line, they may go up and in and the attacking team throws a three man cut out pass, so the defence must stop, hold, and adjust.

This drill will teach players how to react to certain circumstances and adjust to this situation, with the call from the coach.

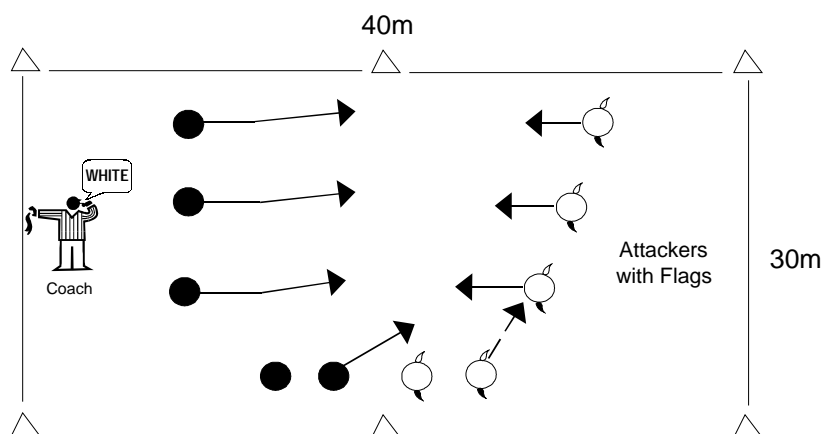

### SET UP:

Grid 30m x 40m long, minimum 10 players, divide players into 2 equal teams. Attacking team have flag belts with red flag on left and white flag on right

### THE DRILL:

- Attacking team starts the drill by playing the ball.
- As ball is being played the coach who is behind the defensive team calls either 'RED' or 'WHITE'. Referring to the flags on the attacking players.
- The defence must then adopt an up and out pattern or a up and in pattern and attempt to shut down the play.

### COACHING POINTS:

Taking yardage off the opposition, communication between players nominating their players in opposition, adopt correct defence procedure to what the coach calls.



VISIT THE  
WEBSITE TODAY!!

## DRILLS BOOK..( 3 )

### **RULES:**

Points can be allocated for: breaking the line, cover defence, try scored or, just use as a coaching drill, stopping the play to question the players movements.

### **POINTS:**

- Defensive players must straighten first before adjusting, do not just adopt an angled run.
- Players on either side of the ruck perform the same movement, (ie up and left or up and right) .

If the play gets switched across the ruck, the defence on the other side of the ruck must now adjust their defensive pattern and adopt an up and in defence because their target zone will be on the left hip. The players must, as in a game, adjust to where the ball goes.

- If the attacking team go to the short side, the defence might do an up and in, if the ball gets switched to the open side, the defence on that side of the ruck should adopt an up and out defence to co-ordinate their defence as their target will be the red flag on the left hip.
- Communication is one of the main facets of this drill, because players will have to call and nominate their man.

If players do not nominate correctly a hole will be created. Commitment and nominating correctly is what this drill will highlight and players will learn to work with a pattern that may change.

- Attackers should be slightly scattered with face ball passes by attackers as a further progression.

### **BENEFITS:**

- Communication skills for defence.
- Attack can develop good line running and how to isolate defenders.
- Decision making in attack, the drill can expose a drifting defence and enables the attack a hole to target.
- If the defence comes in the attack can be shifted wide.
- Both attacking and defensive players need to make reactive decisions.
- This drill may improve vision for decision making.
- Video this drill for playback to study how players react in game situations.



VISIT THE  
WEBSITE TODAY!!

## DRILLS BOOK..( 3 )

# RLCM Drills

## Off-Load Drills

The New Zealand Warriors perfected their ball off-loading skills over the past two years. This skill was part of the ammunition that took them to the 2002 NRL Grand Final. Along the way they created pressure to opposition teams with their ball off-load ability.

Successful offloads can turn a set of six plays into a possible set of seven, eight or even possibly nine plays, think about the pressure that creates on the opposition.

Off loading inside and outside balls are major skills of the game when a team is in possession of the football.

So, how do you practice your offloads?

In this edition we have produced seven offload drills with the courtesy of Dave Stores and the Penrith Panthers. RLCM wants coaches to study and put them to practice, add variations and progressions to suit your players.

Begin a off-load drill at training, create a game related situation, review it, evaluate it, refine it. Take it to the game, if it doesn't work, start over again.

	<input type="radio"/> RLCM	1 - 29
	<input type="radio"/> Drills Books	1 & 2
	<input type="radio"/> Coach Talk	1 & 2
	<input type="radio"/> Junior Coaching	1
<b>Order your CD Now Freecall 1800 18 14 14</b>		



VISIT THE WEBSITE TODAY!!

# DRILLS BOOK..( 3 )

## OFF-LOAD (*Drill 1*)

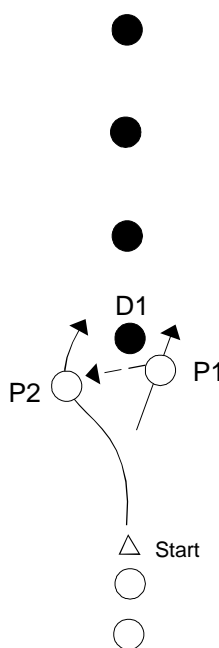

**SET UP:**

Minimum 8 players

**THE DRILL:**

- 6 defenders line up in single file
- P1 runs at D1 moving to the left or right shoulder
- D1 tackles P1, while falling to the ground P1 off-loads to the support player P2
- P2 then continues down the grid with P1 becoming the support player
- Regularly rotate attackers and defenders

**COACHING POINTS:**

Attacker must attempt to move the defender off the line, both to the left and the right. When taking the tackle the player must pass the ball slightly upwards. The ball must be carried in the opposite arm to the side being tackled. Support player must receive the pass and run close on the opposite side to where the attacker has gone.

**VARIATIONS:**

The attacker can draw the defender and pass instead of taking the tackle

**BENEFITS:**

Communication between players, support play, tackling technique



VISIT THE WEBSITE TODAY!!

# DRILLS BOOK..( 3 )

## OFF-LOAD (Drill 2)

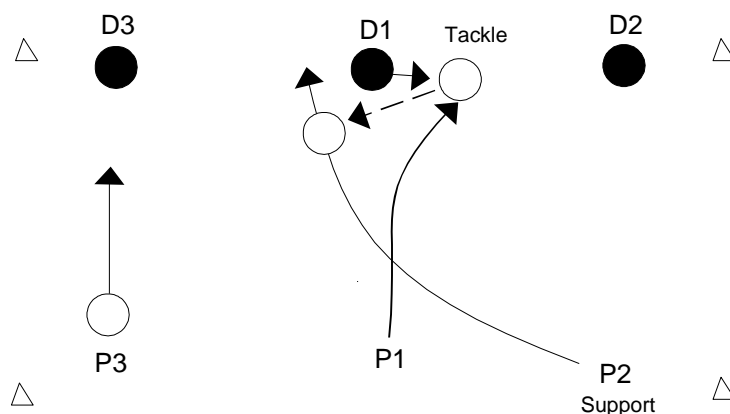

### SET UP:

Minimum 6 players

### THE DRILL:

- P1 runs to D1 moving him to the right
- D1 attempts to tackle P1
- P1 off-loads to P2 in support while falling to the ground
- P3 acts as a dummy runner and keeps D3 out wide to open the gap

### COACHING POINTS:

Attacking player must learn to pull defender out of the line and open up the gap. The deep support player must time his run depending on whether the attacker takes the tackle or passes before the tackle. The outside support must move up and call to sell the dummy play to the defence.

### VARIATIONS:

Switch sides so P2 becomes dummy runner and P1 becomes deep support and attacking player can practice off-loading from both sides. Attacking player can draw defender and pass to deep support player.

### BENEFITS:

Communication between players, support play, tackling technique





VISIT THE  
WEBSITE TODAY!!

## DRILLS BOOK..( 3)

### OFF-LOAD (*Drill 3*)

---

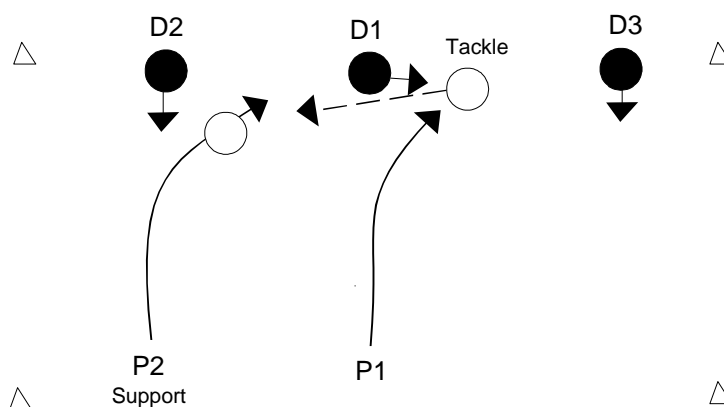

**SET UP:**

Minimum 5 players

**THE DRILL:**

- P1 runs towards D1 and then moves to the right
- D1 attempts to tackle P1
- P2 who has been running straight towards the defence then cuts sharply to the right and moves into support P1
- P1 then off-loads to P2 while falling to the ground
- P2 receives the pass and runs through the gap

**COACHING POINTS:**

The attacking team performs the drill with a flat line attack. Timing is the most important aspect of the drill.

**VARIATIONS:**

Perform drill with attack moving to both left and right sides.  
The attacker can off-load without taking the tackle.

**BENEFITS:**

Communication between players, support play, tackling technique



VISIT THE  
WEBSITE TODAY!!

## DRILLS BOOK..( 3)

### OFF-LOAD (*Drill 4*)

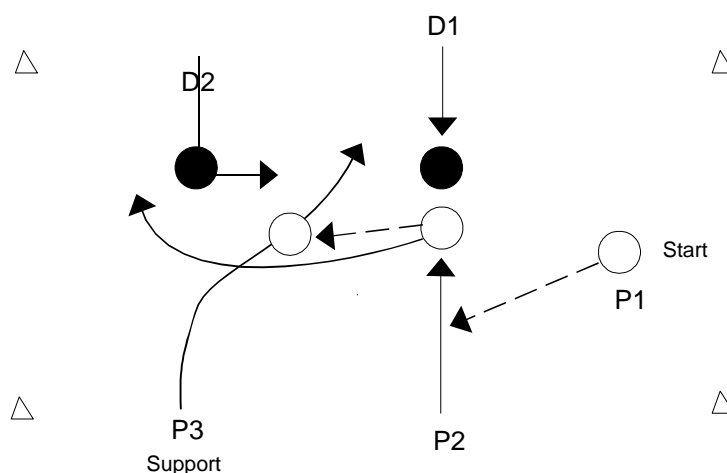

**SET UP:**

Minimum 5 players

**THE DRILL:**

- P1 passes to P2
- P2 runs straight towards defence D1, drawing the player for a short pre-off load to P3 who runs for the gap
- D2 attempts to tackle P3
- P1 doubles around into support and receives the off-load from P3 if the tackle is made

**COACHING POINTS:**

P1 must draw the first defender, P2 must run short and into the gap and be ready to off-load, P1 must react quickly and communicate to let P3 know he is in support

**VARIATIONS:**

Use a second outside support player(P4) to support P3 rather than P1  
P1 can throw a cut pass to P4 and P3 can support

**BENEFITS:**

Communication between players, support play, drawing the man, passing



VISIT THE WEBSITE TODAY!!

# DRILLS BOOK..( 3)

## OFF-LOAD (*Drill 5*)

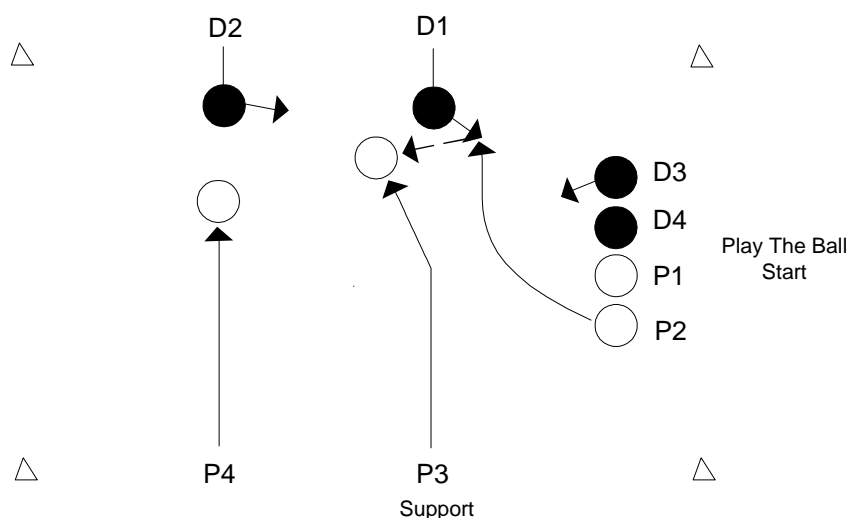

**SET UP:**

Minimum 7 players

**THE DRILL:**

- P1 plays-the-ball P2 (dummy half)
- P2 runs wide, draws the defence (D1) and pre off-loads to P3 who is the first support and running short for the gap
- If P3 gets tackled he can off-load to P4 who is the second support

**COACHING POINTS:**

P2 (dummy half) must run an arc quick enough to beat the marker, support runners must run short and for the gap, dummy half must look to open the gap.

**VARIATIONS:**

P2 (dummy half) can take the tackle and off-load to P3.  
 P2 (dummy half) can throw a cut pass to P4 and P3 becomes the support on the inside or doubling around.

**BENEFITS:**

Communication between players, support play, dummy half play



VISIT THE WEBSITE TODAY!!

# DRILLS BOOK..( 3 )

## OFF-LOAD (Drill 6)

**SET UP:**

Minimum 7 players

**THE DRILL:**

- P1 with ball in hand runs towards D1 who is holding pad
- P1 hits and spins and off-loads to P2 who is the first support player
- P2 then continues down the grid
- D2 runs across as a cover defender and tackles P2
- P2 off-loads while falling to the ground to P3
- P3 runs towards D3 drawing the defender before passing to P4 in support

**COACHING POINTS:**

Support players must run in close support, communicating with the ball carrier.  
 Players learn to beat first, second and third line of defence.

**VARIATIONS:**

Players to off-load from both sides

**BENEFITS:**

Communication between players, support play, decision making

D3 Draw & Pass



Cover Defender D2



D1



Hit, Spin & Off-Load



P1



Start



P2



P3

Support Players



<p>RUGBY LEAGUE COACHING MANUALS</p> <p><small>Since 1993</small></p>	<p><i>"I believe all clubs and coaches at all levels should have a copy of this magazine as a coaching resource"</i></p> <p><b>WAYNE BENNETT</b></p> <p><b>Freecall 1800 18 14 14</b></p>
---	---



VISIT THE WEBSITE TODAY!!

# DRILLS BOOK..( 3)

## OFF-LOAD (*Drill 7*)

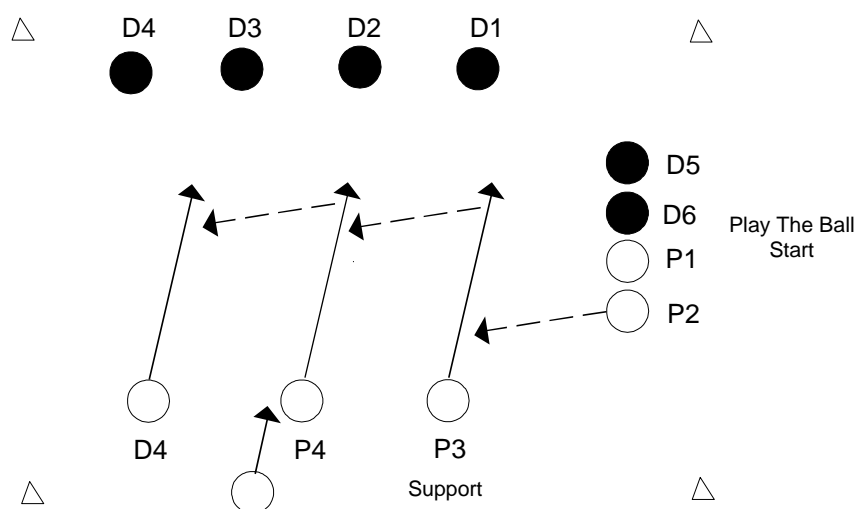

**SET UP:**

Minimum 12 players

**THE DRILL:**

- P1 plays-the-ball P2 (dummy half)
- P2 passes to P3 who is standing wide and running an angle back to the ruck
- P3 off-loads before being tackled to P4 who is in support running the same angle
- P4 then off-loads before being tackled to either P5 who is running the same angle or P6 who is trailing as a second man support. This will depend on whether the defence come off the line to make the tackle.

**COACHING POINTS:**

Pull the defence in tight to the ruck and use the second man support aimed at the edge of the ruck.

**BENEFITS:**

Communication between players, support play, decision making, passing



VISIT THE WEBSITE TODAY!!

## DRILLS BOOK..( 3 )

# RLCM Drills

## *Kicking Drills*

To Order Drills Books '1 & 2' visit [www.rlcm.com.au](http://www.rlcm.com.au)

- |                  |                           |
|------------------|---------------------------|
| 1. Kick & Chase  | 7. Safe Zone              |
| 2. Kick Tennis   | 8. Three Tag Kick         |
| 3. Kick Off      | 9. Bomb & Catch Extension |
| 4. Kick Practice | 10. 'Downtown Kick'       |
| 5. Team Kicking  | 11. Punts for Points      |
| 6. Minefield     |                           |



- |                                       |       |
|---------------------------------------|-------|
| <input type="radio"/> RLCM            | 1- 29 |
| <input type="radio"/> Drills Books    | 1 & 2 |
| <input type="radio"/> Coach Talk      | 1 & 2 |
| <input type="radio"/> Junior Coaching | 1     |

Order your CD Now Freecall 1800 18 14 14



VISIT THE WEBSITE TODAY!!

# DRILLS BOOK..( 3 )

## Kick & Chase

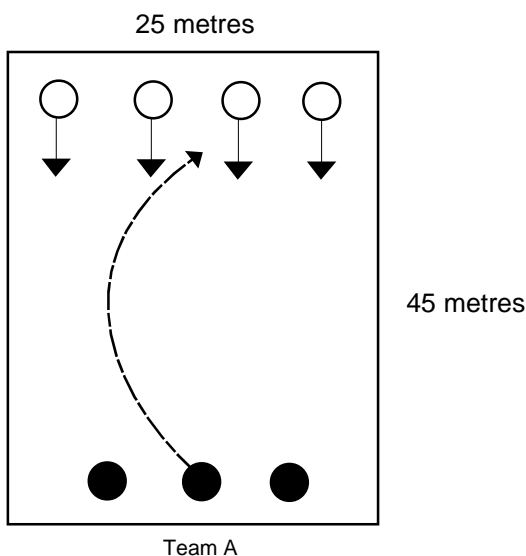

**SET UP:**

Minimum 7 players, 1 football

**THE DRILL:**

- Team A kicks the ball to Team B
- Team B receives the ball and then attempts to beat the chasing defenders
- Team A chase the kick and then defender attempting a two handed grab on the attacking players
- If the play is stopped swap players between attackers and defenders

**VARIATIONS:**

- Bring the sideline boundary in
- Allow the kicking side to chip or grubber kick

**COACHING POINTS:**

Encourage the kicking side to chase quickly as in a game and move up, talking in a straight line of defence. The receiving side should have a clear call and the other players should move up quickly into position to support him.

**BENEFITS:**

Kicking, communication between players, support play, defence and attack



VISIT THE WEBSITE TODAY!!

# DRILLS BOOK..( 3)

## Kick Tennis

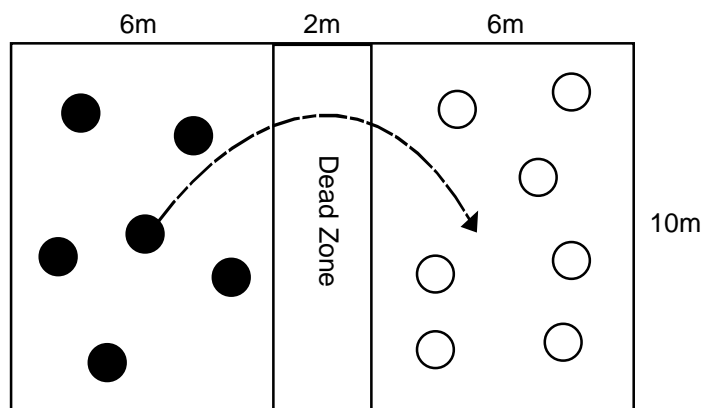

**SET UP:**

Equal number of players, 1 football

**THE DRILL:**

- Divide players into two equal teams
- Ball is kicked back and forth between the two teams
- Neither team may enter the dead area
- Players to use short, stab, chip or high kicks across the dead area
- Receivers must attempt to catch the ball on the full
- The ball MUST:-
  - Not land in the 'dead area' (Kicker removed)
  - Not land in kickers area (Kicker removed)
  - Land inside receivers area (Closest receiver removed)
  - Land outside area without being touched (Kicker removed)
  - Dropped ball (Receiver removed)

**VARIATIONS:**

- Put a 4 second count on receiving and kicking
- Increase area
- Widen 'dead' area

**COACHING POINTS:**

Create an environment of pressure, reaction, hand eye co-ordination, timing and anticipation of the kick.

**BENEFITS:**

Kicking skills, communication





VISIT THE WEBSITE TODAY!!

# DRILLS BOOK..( 3 )

## Kick Off

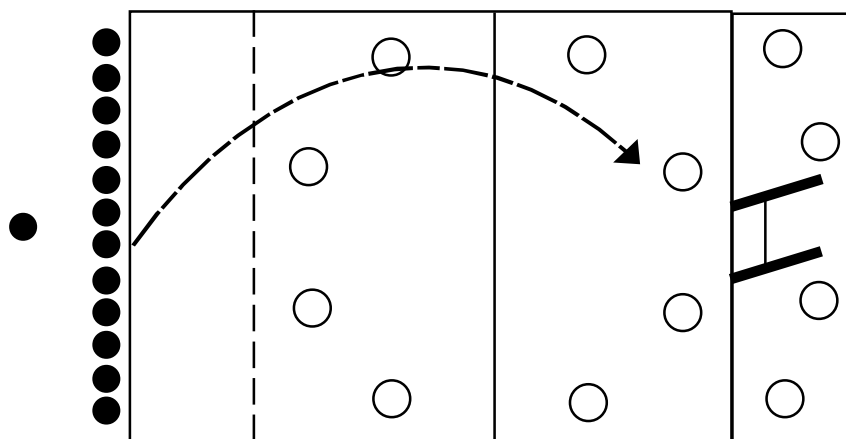

**SET UP:**

Two teams, 1 football

**THE DRILL:**

- Divide players into two equal teams
- Each team has a turn of kicking off and attempting to force an error by the opposition
- Award points for the level of play
  - Kicking the ball dead (10 points)
  - Finding a touch line (10 points)
  - Regaining the ball from the kick off (10 points)
  - Chaser keep the opposition in their own 10 metre zone (10 points)
  - Kicking off and the ball touched the ground (5 points)
  - Chasers keep the opposition in their own 20 metre zone (5 point)

**VARIATIONS:**

- Increase or decrease the number of players
- Allow attack to play using two handed grabs by defenders

**COACHING POINTS:**

Chasers to communicate with kicker to know what kick is on, receivers to be in set positions, ready to receive or move into support play.

**BENEFITS:**

Catching, communication, kick - chase and return, kicking



VISIT THE  
WEBSITE TODAY!!

## DRILLS BOOK..( 3)

# Kick Practice

---

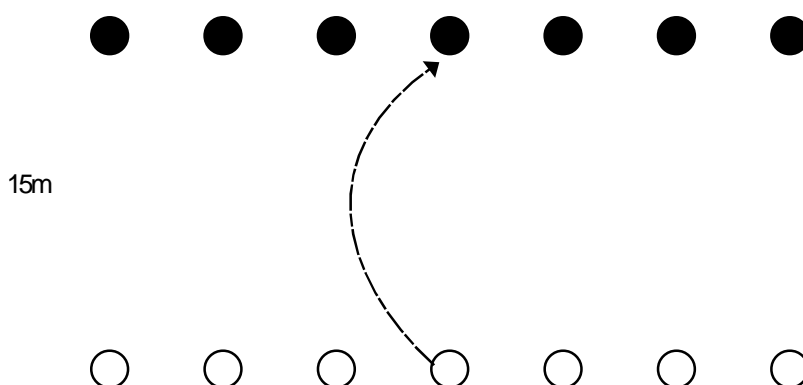

### SET UP:

Players in pairs, minimum 2 players, 1 football per pair

### THE DRILL:

- Players stand opposite each other - 15 metres apart
- Kicking the back and forth
- Players to perform grubber kicks, chip kicks and drop kicks
- Players to perform each kick with both left and right feet

### VARIATIONS:

- Put a 4 second count on receiver and kicking the ball
- Increase distance between pair
- Create a game situation where players chose different kicks and try to force and error by the receiver

### COACHING POINTS:

Kicks to be controlled, encourage left and right foot kicks

### BENEFITS:

Kicking and catching skills



VISIT THE WEBSITE TODAY!!

# DRILLS BOOK..( 3)

## Team Kicking

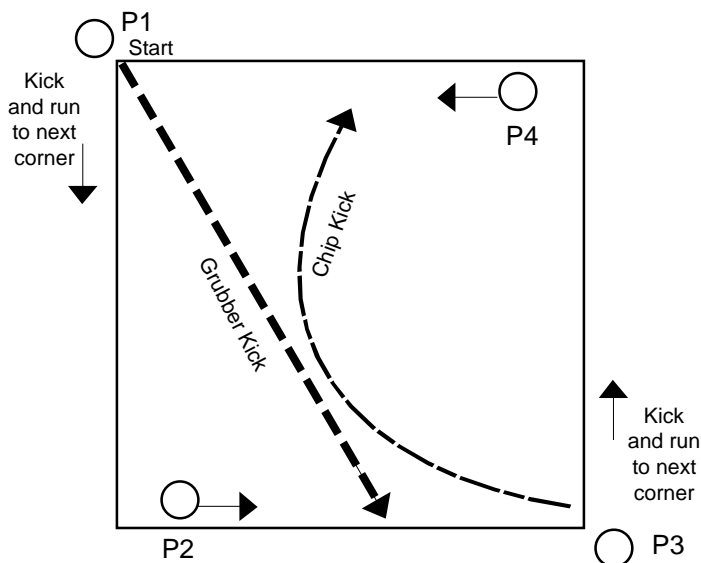

**SET UP:**

5 Players per group, 1 football

**THE DRILL:**

- Drill starts with P1 grubber kicking across the grid for P2
- P2 regathers on the run and hands off to P3
- P3 chip kicks across the grid for P4
- P4 catches the ball on the full and runs through to the corner of the grid
- P4 becomes P1 and recommences the drill by grubbering across the grid
- (After kicking P1 moves to P2 and P3 moves to P4)

**VARIATIONS:**

- Use left and right feet
- Change direction

**COACHING POINTS:**

Kicks to be controlled and allowing for the receiver to run onto the ball. Receiver to time his regather and not overrun the ball

**BENEFITS:**

Kicking and catching skills, communication



VISIT THE  
WEBSITE TODAY!!

## DRILLS BOOK..( 3)

# Minefield

---

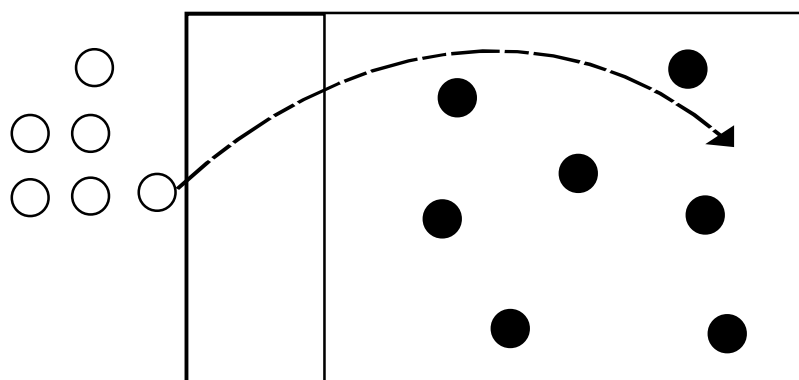

### SET UP:

1 football, make grid size to suit player numbers

### THE DRILL:

- Defending players scatter themselves throughout the grid
- P1 attempts to kick the football into the grid and have it land, 1st bounce in open space
- 1 point is awarded for each successful kick
- The kicking team loses a life when:-
  - the ball is kicked out of bounds on the full
  - the ball is caught by the defending team on the full
- When 3 lives are lost, roles are reversed

### VARIATIONS:

- Use left and right feet
- Penalise defending team for dropped ball

### BENEFITS:

Kicking and catching skills, decision making



VISIT THE  
WEBSITE TODAY!!

## DRILLS BOOK..( 3 )

# Safe Zone

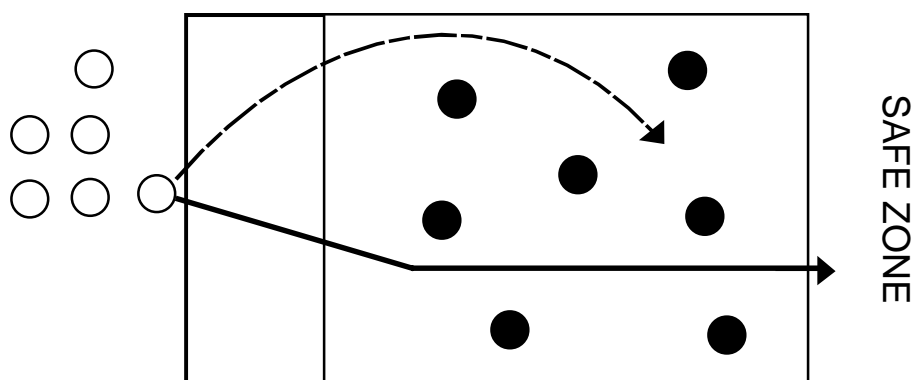

### SET UP:

1 football, make grid size to suit player numbers

### THE DRILL:

- Defending players scatter themselves throughout the grid
- P1 attempts to kick the football into open space and then run the length of the grid to the safe zone without being touched
- Defenders must regather and attempt to tag P1 with the ball
- Defenders may pass or kick the ball amongst each other and they may run with it in hand
- P1 is out if the ball is caught on the full or is tagged with the football
- Award 1 point for every player who reaches the safe zone, after 3 outs players swap roles

### VARIATIONS:

- Use left and right feet
- Penalise defending team for dropped ball or bad passes

### COACHING POINTS:

Defenders to communicate, kickers to use evasive skills to reach the safe zone

### BENEFITS:

Kicking and catching skills, communication, decision making , evasion



VISIT THE  
WEBSITE TODAY!!

## DRILLS BOOK..( 3 )

# Three Tag Kick

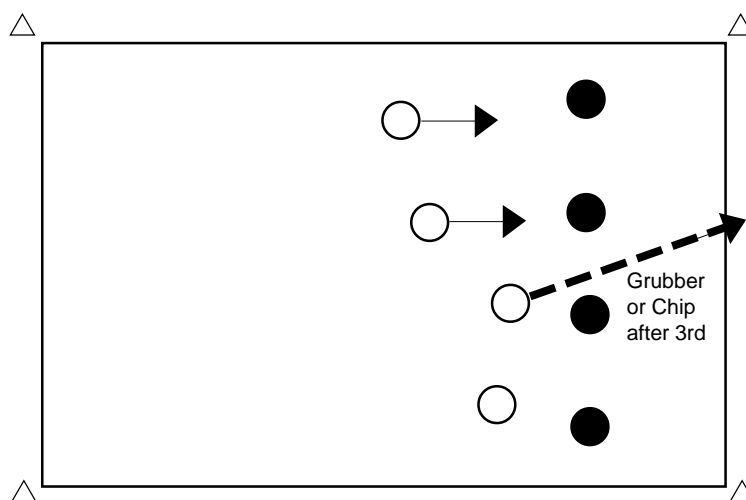

### SET UP:

1 football, 2 even teams

### THE DRILL:

Touch game with modified rules and attack 'last play' options

- Divide players into 2 equal teams
- Attacking team has 3 plays only to score before change over
- Attacking team has the option to kick on any play
- A kick and regather in the field restarts the tackle count for the attacking team
- Points awarded for each try with more points awarded for tries that results from a kick or involved with a kick
- Award 1 point for putting in a kick and then tagging defenders in the in-goal

### COACHING POINTS:

Penalise with a change over any off-side players or incorrect play the balls.  
Players to communicate in both attack and defence.

### BENEFITS:

Last play options, decision making



VISIT THE WEBSITE TODAY!!

# DRILLS BOOK..( 3)

## Bomb & Catch Extension

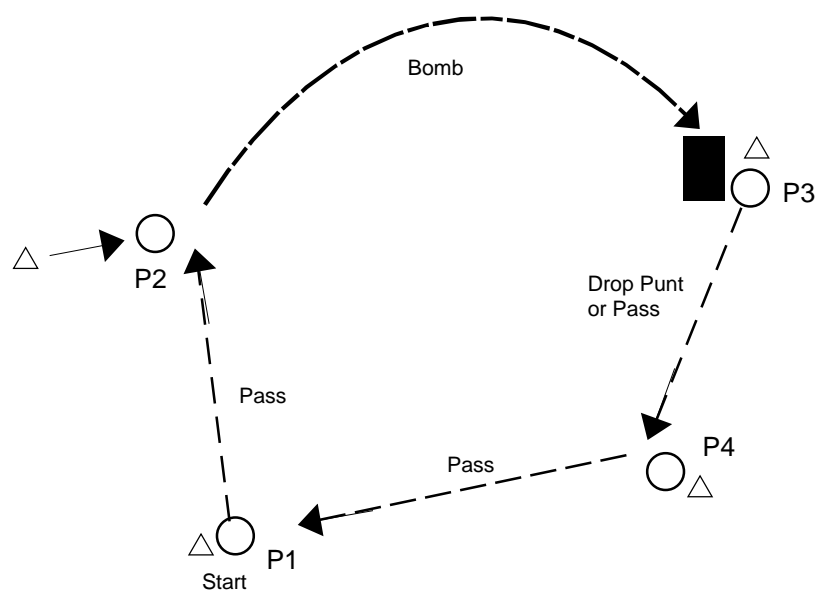

**SET UP:**

2 footballs, 1 tackle bag, 4 players per group

**THE DRILL:**

- P1 has 2 balls at his feet and starts the drills by making a dummy half pass to P2 (this pass should be out in front to make P2 run onto the ball)
- P2 then kicks a high ball ('bomb') attempting to land the ball on the tackle bag near P3 (he does not aim at P3 but at the bag)
- P3 catches the ball and immediately passes or drop punts to P4 who then passes to P1 and the drill continues

**VARIATION**

- Add second football into drill, after P2 has kicked ball and returned to marker, P1 passes second ball
- Add third football

**BENEFITS:**

Kicking, catching, passing



VISIT THE WEBSITE TODAY!!

# DRILLS BOOK..( 3 )

## ‘Downtown’ Kick

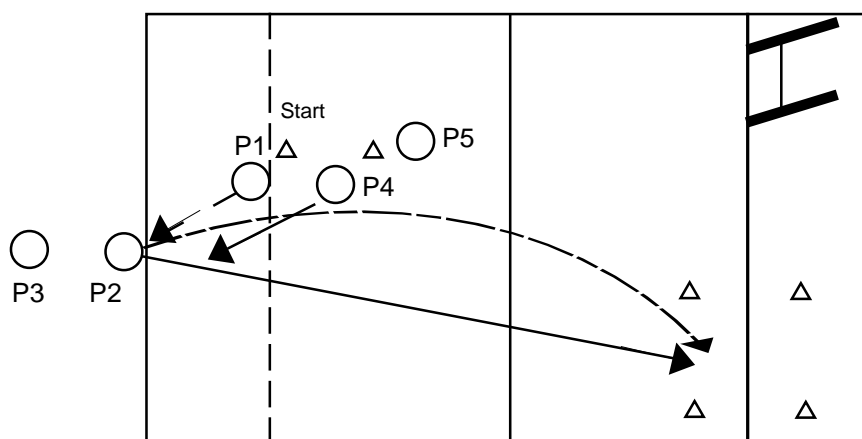

**SET UP:**

4 footballs, 5 players

**THE DRILL:**

- Set up cones to mark out a box about 10 metres square in the corner 5 metres in front of the try and 5 metres behind it
- Set up a Play the ball situation with P1 acting as dummy half
- P2 and P3 are the receivers and take turns in practising their downtown kicks
- The kicker must chase the ball as would on a 5th play
- The kick is aimed at the 10 metre square
- P4 and P5 are used to retrieve the ball from the returning kick and take turns on putting pressure on P2

**VARIATION**

- Use more players to put pressure on the kicker
- Adjust the position of the corner box or play the ball
- Have the kick stand on the left or right side of the play the ball

**COACHING POINTS**

- Proficiency can take time, allow players to make mistakes and encourage them to keep practising

**BENEFITS:**

Kicking under pressure, accurate kicking





VISIT THE WEBSITE TODAY!!

# DRILLS BOOK..( 3 )

## Punt for Points

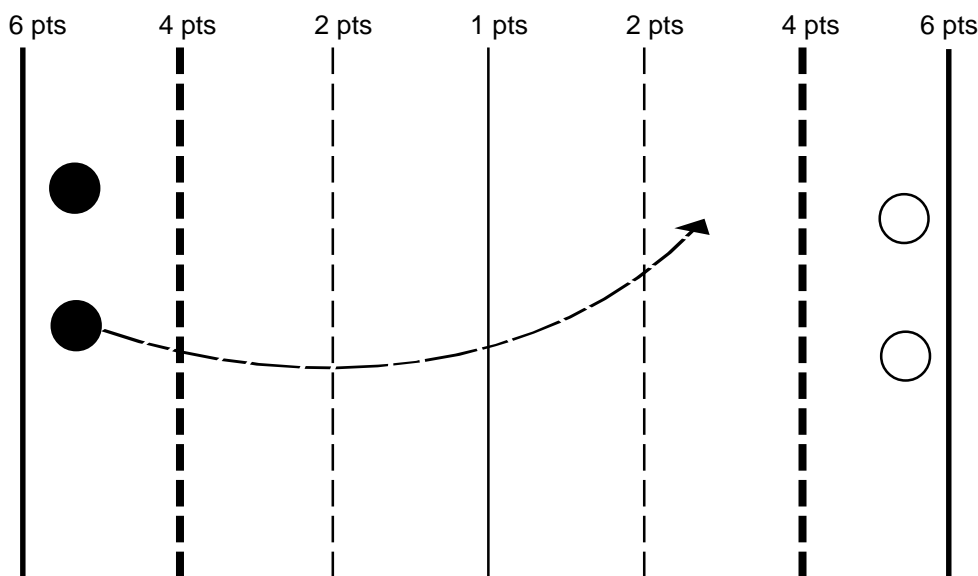

**SET UP:**

1 football

**THE DRILL:**

- A distance and accuracy kicking competition
- Players pair up with each player either punt, drop or torpedo kicking down a 15m channel. The length should be determined by the age and skill level of the players
- Each player has a set number of kicks (eg. 5) from each end of the grid
- Points awarded on the quality of kick - length and accuracy, no points are awarded if the ball lands outside the grid

**COACHING POINTS**

- Depending on the type kick the following should be addresses: ball grip, ball drop, leg action, strike and trajectory.



VISIT THE  
WEBSITE TODAY!!

# DRILLS BOOK..( 3 )

## rlcm.com.au

The publishers wish to thank the Australian Rugby League and contributors for their assistance in compiling this publication.

**Queensland**  
Suite 1F, Trust House  
3070 Gold Coast Hwy  
Surfers Paradise  
QLD AUST. 4217

PO Box 259,  
Surfers Paradise  
QLD AUST. 4217  
Ph: (07) 5538 9377  
Fax: (07) 5538 9388

**New South Wales**  
Suite 111  
353 King Street  
Newtown  
NSW AUST. 2042

Locked Bag 18/111  
Newtown  
NSW AUST. 2042  
Ph: 1800 18 14 14  
Fax: 1800 18 14 15

**UNITED KINGDOM**  
The Conifers, 1 New Lane,  
Skelmanthorpe,  
Huddersfield  
West Yorkshire  
UK HD8 9EH  
Email: england@rlcm.com.au

**NEW ZEALAND**  
132 Victoria Road,  
St Kilda, Dunedin,  
New Zealand  
Fax (03) 456 3498,  
Email: rlcm@ihug.co.nz

**Publisher**  
Gary Roberts  
rlcm@rlcm.com.au

**Research**  
Keith Hookway  
keith@rlcm.com.au

**Editor**  
Terry Prindable  
editorial@rlcm.com.au

**Production**  
Reagan Roberts  
reaganr@ozemail.com.au

**Contributors**  
Digi League  
NSWRL Academy  
John Dixon  
Glenn Bayliss  
Dave Stores



### DISCLAIMER

The information in this publication is given in good faith and has been derived from sources believed to be reliable and accurate. However, neither Shamrock Books, nor any person involved in the preparation of this publication accept any form of liability whatsoever for its contents including advertisements, editorials, opinions, advice or information or for any consequence for its use.

**No part of this publication may be reproduced, stored in any retrieval system, or transmitted in any form or by any means electronic, mechanical, photocopying, recording or ink-jet printing without prior written permission of the publishers.**

Published by Senior Scene Pty Ltd  
T/A Shamrock School Books  
ABN 82 050 409 268

Rugby League Coaching Manuals  
ISSN 1446-3628

www.rlcm.com.au